



Introduction to Diffraction

Maria Beatriz Gay Ducati

GFPAE – IF-UFRGS

beatriz.gay@ufrgs.br

CTEQ :: 2012 Summer School
July 30-August 09, 2012 – Lima, Peru

Outline

➤ Review of diffraction

- ✓ Mandelstam variables
- ✓ Regge Theory
- ✓ Pomeron

➤ Diffraction at HERA

- ✓ Deep Inelastic Scattering
- ✓ Diffractive DIS
- ✓ Diffractive Structure Functions

➤ Diffraction at Tevatron

- ✓ Diffraction at Tevatron
- ✓ Hadronic case
- ✓ Diffractive Structure Functions

➤ Diffraction at LHC

- ✓ Partonic Structure of the Pomeron
- ✓ Results

- ✓ W / Z production
- ✓ Higgs Production

Processes in channels s and t

- Two body scattering can be calculated in terms of two independent invariants, s and t, Mandelstam variables

where

$$\begin{cases} s = (A + B)^2 = (C + D)^2 \\ t = (A - C)^2 = (B - D)^2 \end{cases}$$

Square of center-of-mass energy

Square of the transferred four momentum

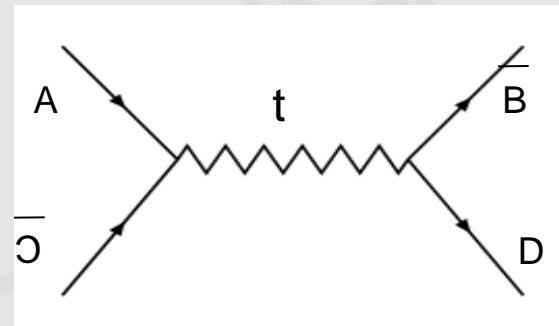
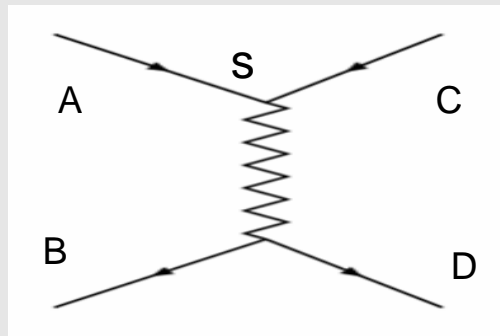

$$A_{AB \rightarrow CD}(s, t) = A_{A\bar{C} \rightarrow \bar{B}D}(t, s) \quad \Rightarrow \quad \text{by crossing symmetry}$$

$$A(s, t) \approx \frac{g^2}{m_\pi^2 - t} \quad \Rightarrow \quad \text{pion exchange}$$

$g \rightarrow$ coupling constant

Singularity (pole) in non-physical region $t > 0$ in s-channel diagram $\Rightarrow t = m_\pi^2$

What is Diffraction?

- Diffraction is characterized as a colour singlet exchange process in pp physics
- Described in terms of t channel exchanges

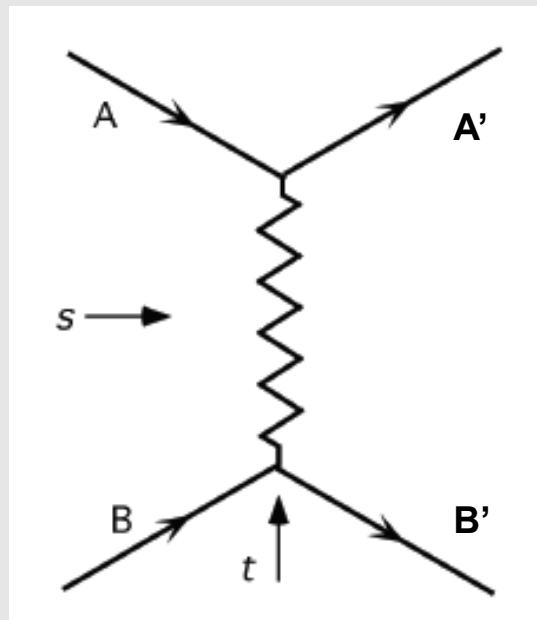

What is exchanged in t channel?

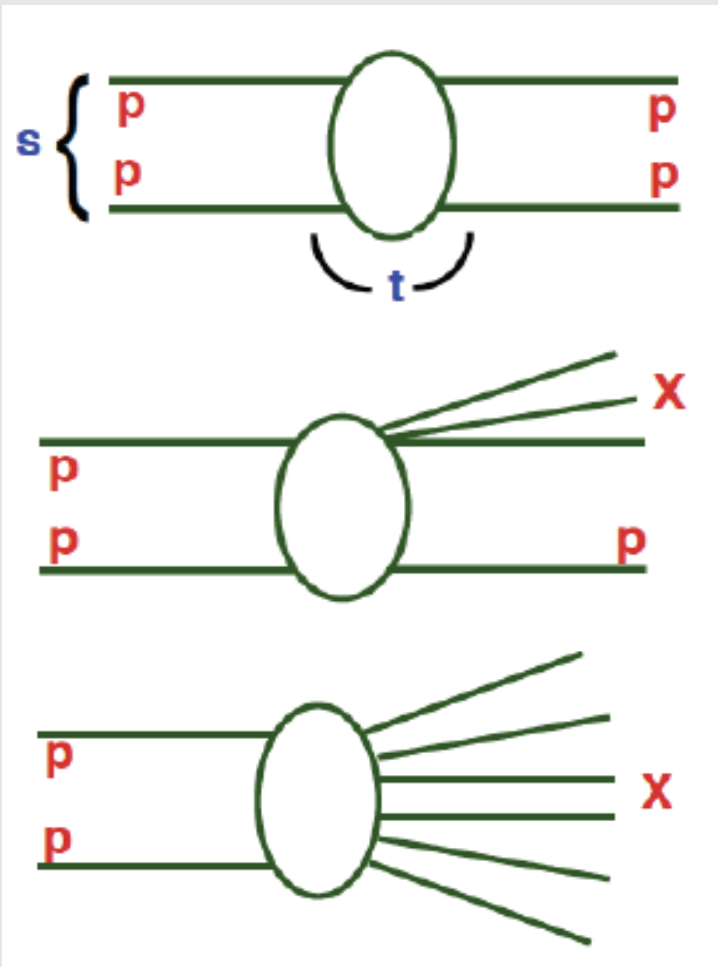

Elastic

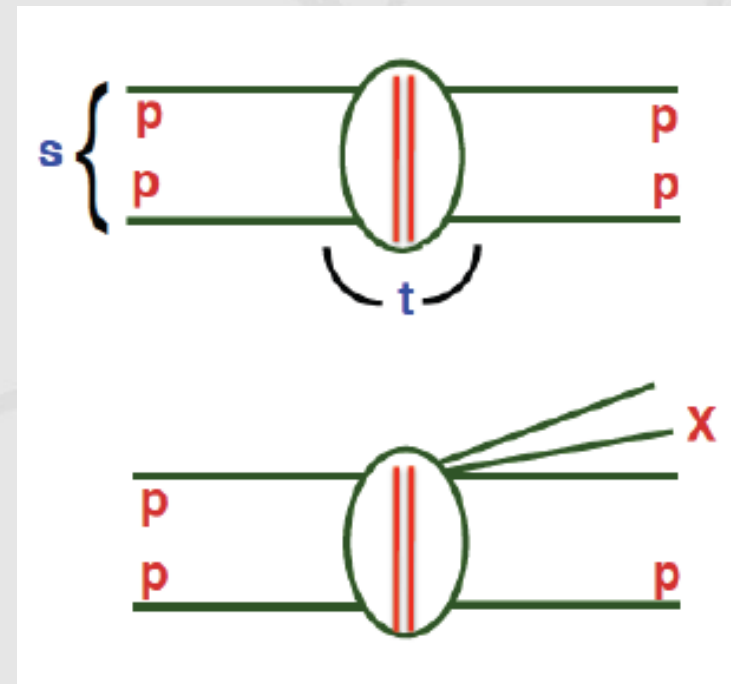

SD

DPE

Regge Theory

✓ Resonances as observables in t channel

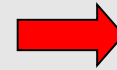

meson exchange

✓ t channel trajectory



Resonances with same quantum numbers

$$\alpha(t) = \alpha(0) + \alpha' t$$



slope

✓ Amplitudes through partial waves decomposition

$$A(s, t) \approx \sum_{l=0}^{\infty} (2l+1) A_l(t) P_l(\cos\theta)$$

$A_l(t)$ sum on poles (**Reggeons**)

$$\frac{d\sigma}{dt} \approx \frac{1}{s^2} |A(s, t)|^2 = g(t) \left(\frac{s}{s_0} \right)^{2\alpha(t)-2}$$

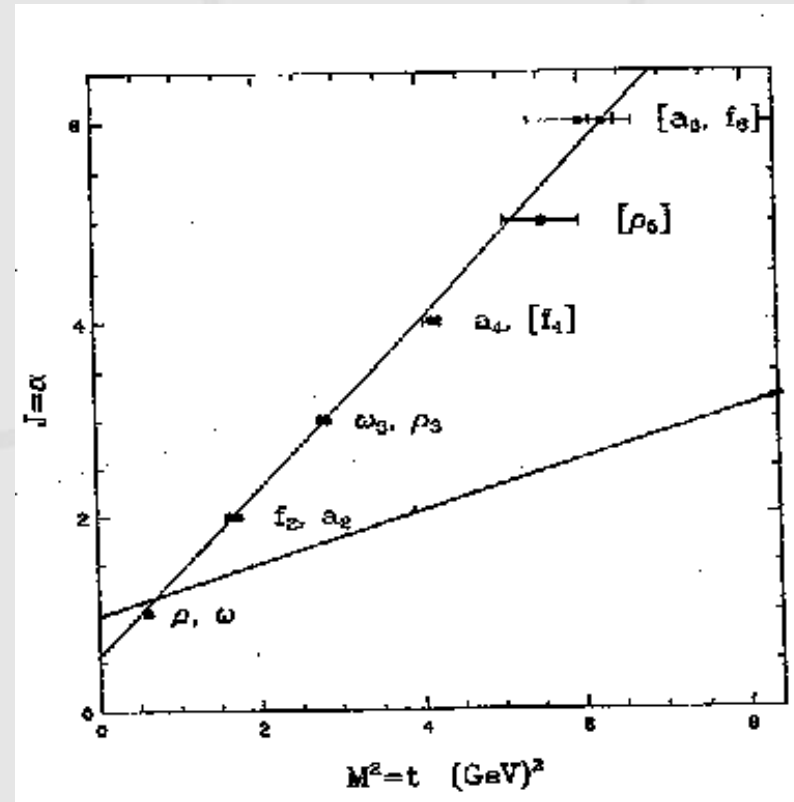

Good for hadron interactions with low momentum transfer $\pi^- p \rightarrow \pi^0 n$

Regge Theory

- At fixed t , with $s \gg t$
- Amplitude for a process governed by the exchange of a trajectory $\alpha(t)$ is

$$A(s,t) \sim \left(s/s_0\right)^{\alpha(t)}$$

- No prediction for t dependence
- Elastic cross section

$$\frac{d\sigma_{el}}{dt} \sim s^{2\alpha(t)-2}$$

- Total cross section considering the optical theorem

Diffractive scattering

Consider elastic $A B \rightarrow A B$

$$\frac{d\sigma_{el}}{dt} \approx \frac{1}{s^2} \sum_X \left| \begin{array}{c} \text{Diagram 1: Two red circles connected by a double line labeled X. Incoming particles A and B on the left, outgoing particles A and B on the right.} \end{array} \right|^2 \approx \frac{1}{s^2} \left| \begin{array}{c} \text{Diagram 2: A vertex labeled } \alpha(t) \text{ with a dashed vertical line. Incoming particles A and B on the left, outgoing particles A and B on the right.} \end{array} \right|^2 \approx s^{2\alpha(t)-2}$$

optical theorem

$$\sigma_{tot}^{AB} \approx \frac{1}{s} \text{Im} \left(A_{el}^{AB} \right)_{t=0} \approx s^{\alpha(0)-1}$$

$$\sigma_{tot} = \frac{1}{2s} \sum_X \left| \begin{array}{c} \text{Diagram 3: A red circle with incoming particles A and B, and multiple outgoing lines labeled X.} \end{array} \right|^2 = \frac{1}{2s} \sum_X \left| \begin{array}{c} \text{Diagram 4: Two red circles connected by a double line. Incoming particles A and B on the left, outgoing particles A and B on the right.} \end{array} \right|^2 \approx \frac{1}{s} \left| \begin{array}{c} \text{Diagram 5: A vertex labeled } \alpha(0) \text{ with a dashed vertical line. Incoming particles A and B on the left, outgoing particles A and B on the right.} \end{array} \right|^2$$

by Regge

$$\alpha(0) \approx 1 + \varepsilon, \quad \alpha(0) \leq 0.5$$

$\left\{ \begin{array}{l} \text{vacuum trajectory} \\ \text{Pomeron } \alpha_{IP}(t) \\ \text{vacuum quantum numbers} \end{array} \right.$

Regge theory

$\sigma_T \propto$ IP exchange



σ_{dif} vacuum quantum numbers

**Hadrons
scattering**

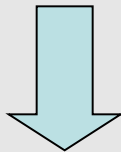

Following particle
distribution in rapidity

Elastic

Single

Double

Double Pomeron Exchange

Totally Inelastic

diffraction

Rapidity

Inelastic scattering

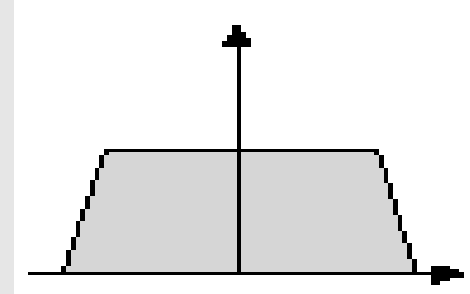
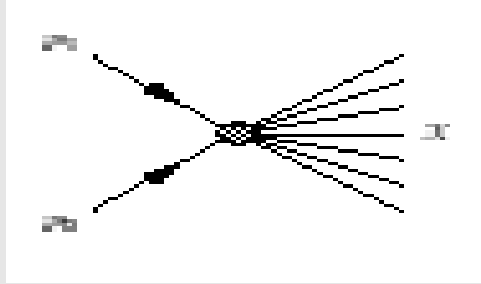

Rapidity

$$y = \frac{1}{2} \ln \frac{E + p_z}{E - p_z} \approx -\ln \tan \frac{\theta}{2} = \eta$$

η \Rightarrow pseudorapidity for a particle with (E, \vec{p}_\perp, p_z) and polar angle θ

Diffraction defined by

- \Rightarrow leading proton
- \Rightarrow large rapidity gap

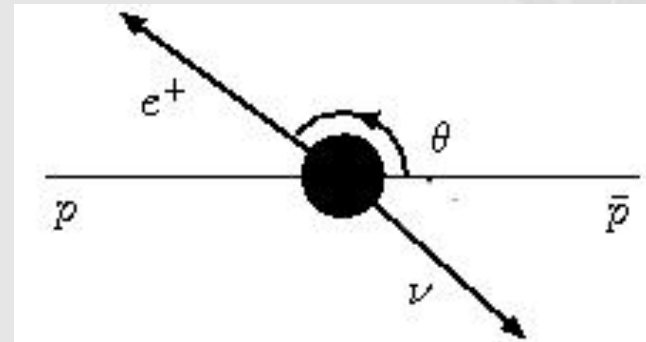

Diffractive processes

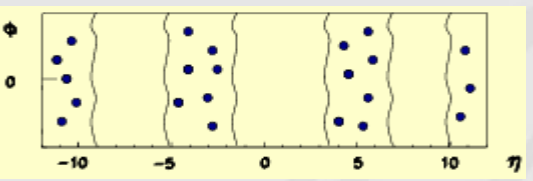
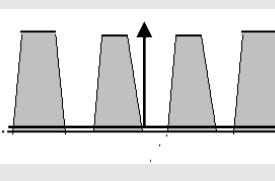
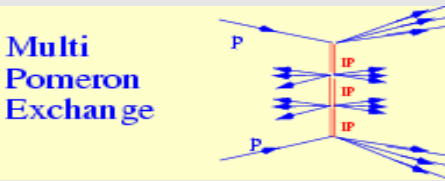
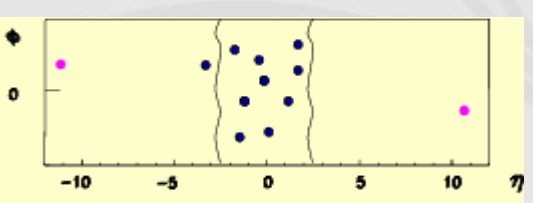
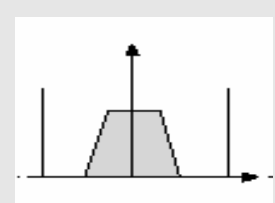
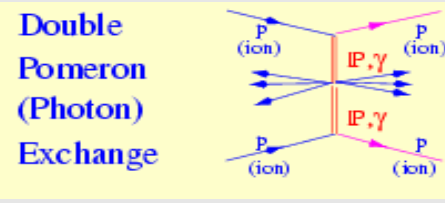
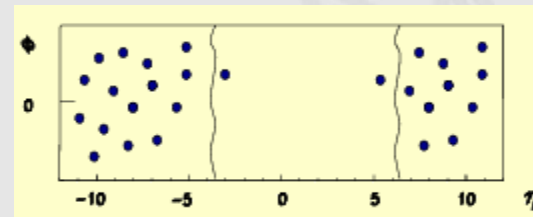
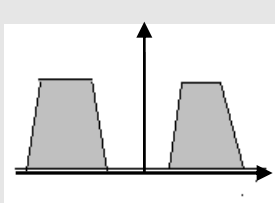
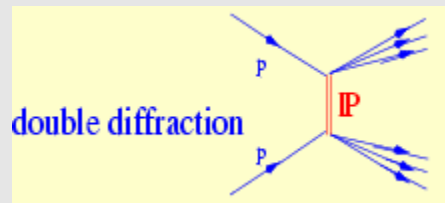
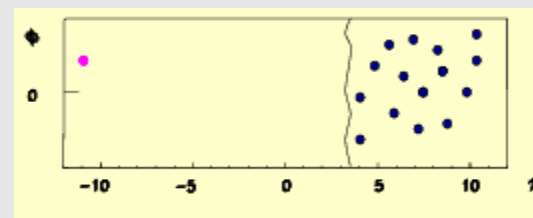
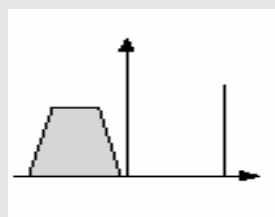
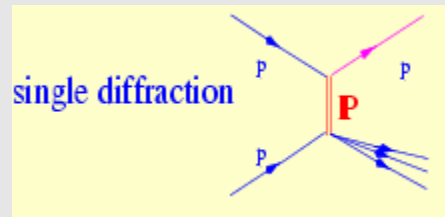
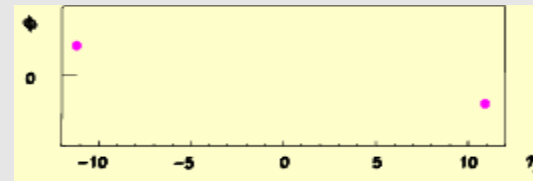
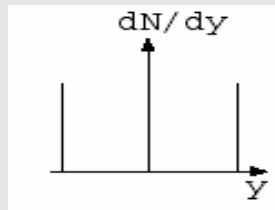
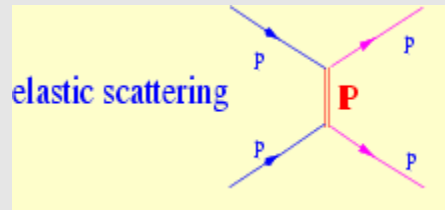

Tevatron/LHC
Higgs: NLO
W, Z
QQ: NRQCD, NLO

Tevatron/LHC
Higgs: photo-, NLO
QQ: NLO

Regge phenomenology in QCD

- Elastic amplitude \Rightarrow mediated by the Pomeron exchange

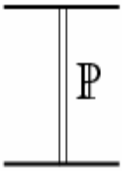

$$A_{\text{el}}(t) \propto \left[i - \text{ctg} \frac{\pi \alpha_{\mathbb{P}}(t)}{2} \right] \left(\frac{s}{s_0} \right)^{\alpha_{\mathbb{P}}(t) t}$$

$$\alpha_{\mathbb{P}}(t) = \alpha_{\mathbb{P}}^0 + \alpha'_{\mathbb{P}} t$$

What is the Pomeron?

- A Regge pole: not exactly, since $\alpha_{\mathbb{P}}(t)$ varies with Q^2 in DIS
- DGLAP Pomeron \Rightarrow specific ordering for radiated gluon

$$k_{i+1}^2 < k_i^2 \leq Q^2 \quad \text{and} \quad x \leq x_{i+1} \leq x_i$$

- BFKL Pomeron \Rightarrow no ordering \Rightarrow no evolution in Q^2
- Other ideas?

The Pomeron

- ❖ Regge trajectory has intercept which does not exceed 0.5
- ❖ Reggeon exchange leads to total cross sections decreasing with energy
- ❖ Experimentally, hadronic total cross sections as a function of s are rather flat around

$$\sqrt{s} \sim (10 - 20) \text{ GeV}^2$$

INCREASE AT HIGH ENERGIES

- ❖ Chew and Frautschi (1961) and Gribov (1961) introduced a **Regge trajectory** with **intercept 1** to account for asymptotic total cross sections
- ❖ This reggeon was named **Pomeron** (IP)

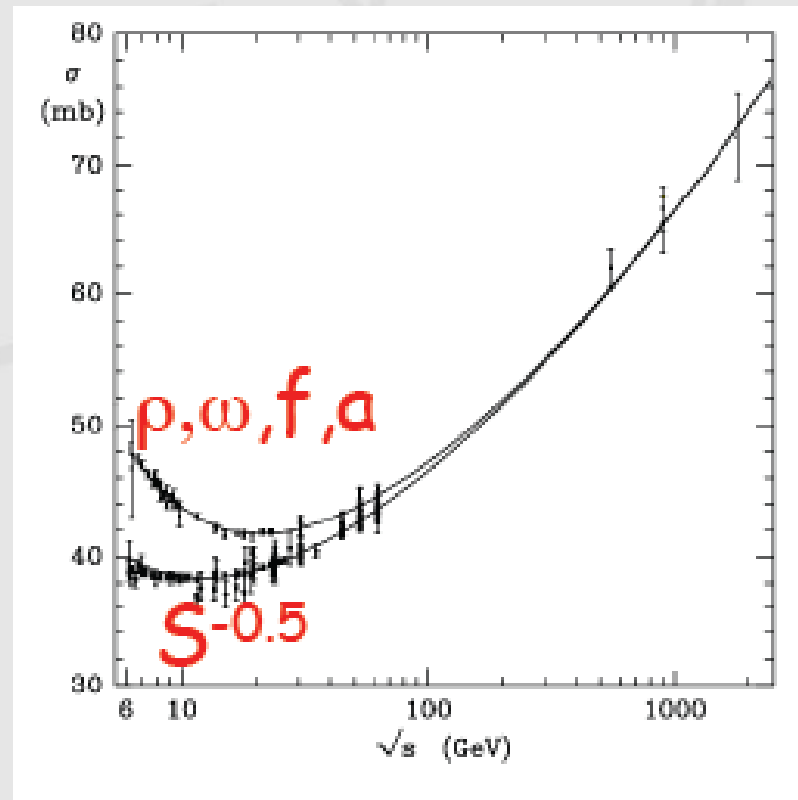

The Pomeron

o From fitting elastic scattering data

 *IP* trajectory is much flatter than others

$$\alpha'_{IP} \approx 0.25 \text{ GeV}^{-2}$$

o For the intercept  total cross sections implies

$$\alpha_{IP}(0) \approx 1$$

o Pomeron  dominant trajectory in the elastic and diffractive processes

o Known to proceed via the exchange of vacuum quantum numbers in the t -channel

$$IP: \quad P = +1; \quad C = +1; \quad I = 0;$$

Pomeron trajectory

Regge-type

$$\frac{d\sigma}{dt}(W) = \exp(b_0 t) W^{2[2\alpha_{IP}(t)+2]}$$

$$W^2 = (q+p)^2$$

❖ First measurements in h-h scattering

$$\alpha(t) = \alpha(0) + \alpha' t$$

Soft Pomeron values

$$\alpha(0) \sim 1.09$$

$$\alpha' \sim 0.25$$

✓ $\alpha(0)$ and α' are **fundamental parameters** to represent the basic features of strong interactions

✓ $\alpha(0)$ \longrightarrow energy dependence of the diffractive cross section

$$\frac{d\sigma}{dt}(W) = W^{\underline{4\alpha(0)-4}} \exp(bt)$$

$$b = b_0 + 4\alpha' \ln(W)$$

✓ α' \longrightarrow slope

Diffractive scattering

$$\alpha_{IP}(t) = 1.085 + 0.25t \quad (p\ p, p\ \bar{p})$$

The interactions described by the exchange of a IP are called **diffractive**

so

$$\frac{d\sigma_{tot}^{AB}}{dt} \approx \frac{\beta_{AIP}^2(t) \beta_{BIP}^2(t)}{16\pi} s^{2\alpha_{IP}-2}$$

β_{iIP} \longrightarrow Pomeron coupling with external particles

Valid for $s \rightarrow \infty, \quad t/s \rightarrow 0$

High s \longrightarrow $\sigma_{tot}^{AB} \approx \beta_{AIP}(0) \beta_{BIP}(0) s^{\alpha_{IP}-1}$

Studies of diffraction

o In the beginning \longrightarrow hadron-hadron interactions

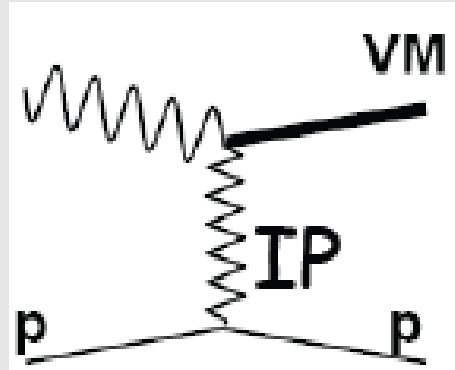

SOFT

low momentum transfer

o Exclusive diffractive production: ρ , ϕ , J/ψ , Υ , γ

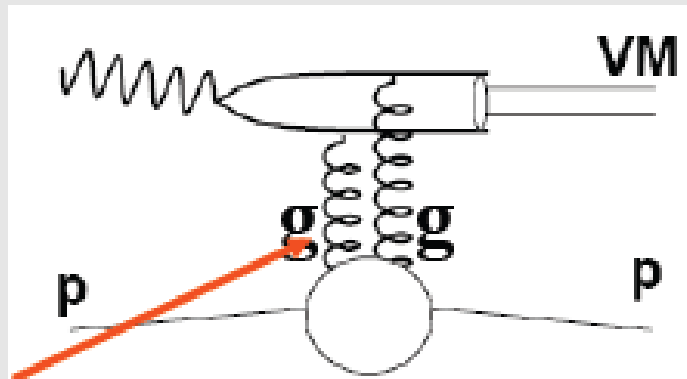

HARD

high momentum transfer

Gluon exchange

Studies of diffraction

o Cross section

$$\sigma(W) \propto W^\delta$$

o δ expected to increase from soft (~ 0.2 is a “soft” Pomeron) to hard (~ 0.8 is a “hard” Pomeron)

o Differential cross section

$$\frac{d\sigma}{dt} \propto e^{-b|t|}$$

o b expected to decrease from soft ($\sim 10 \text{ GeV}^{-2}$) to hard ($\sim 4 - 5 \text{ GeV}^{-2}$)

Froissart limit

- No diffraction within a black disc
- It occurs only at periphery, $b \sim R \Rightarrow$ in the Froissart regime, $R \propto \ln(s)$
- Unitarity demands

$$\begin{array}{l} \sigma_{tot} \propto \sigma_{el} \propto \ln^2(s) \\ \sigma_{sd} \propto \ln(s) , \end{array} \quad \Rightarrow \quad \text{i.e.} \quad \underline{\sigma_{sd}/\sigma_{tot} \propto 1/\ln(s)}$$

- Donnachie-Landshoff approach \Rightarrow may not be distinguishable from logarithmic growth

Any s^λ power behaviour would violate unitarity



At some point should be modified by unitarity corrections

- Rate of growth $\sim s^{0.08}$ would violate unitarity only at **large energies**

Some results

- ✓ Many measurements in pp
- ✓ Pomeron exchange trajectory

$$\alpha(t) \sim 1.10 + 0.25 t$$

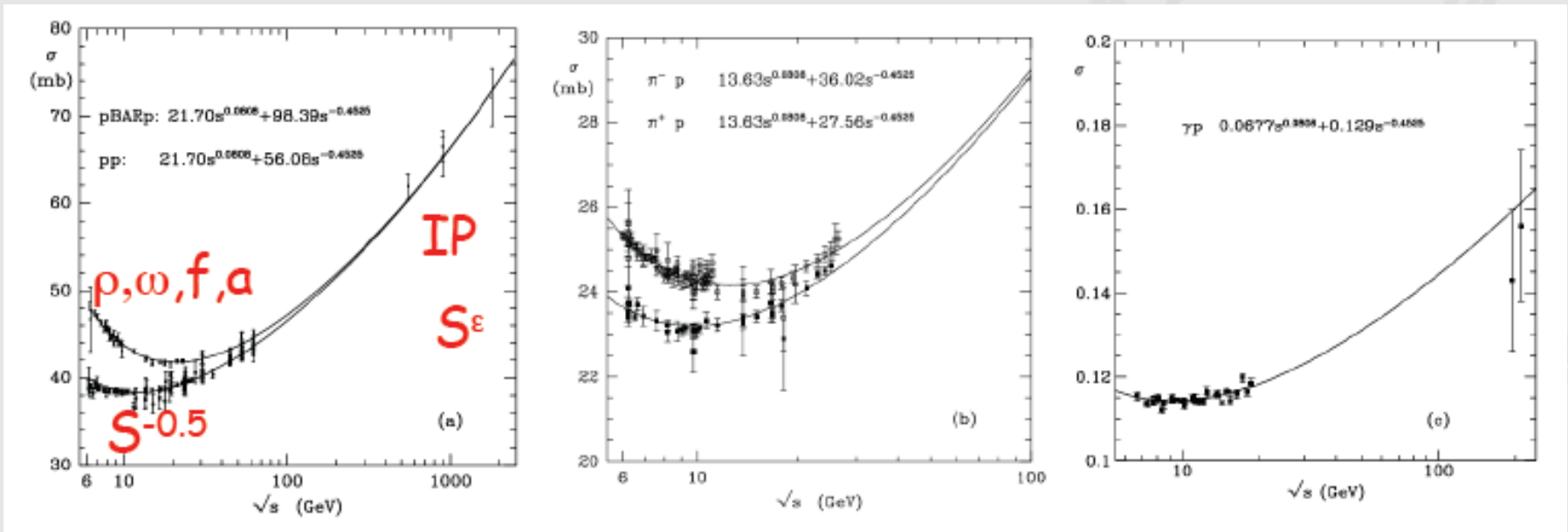

 Pomeron universal and factorizable
 applied to total, elastic, diffractive dissociation cross sections in
ep collisions

DIFFRACTION AT HERA

HERA

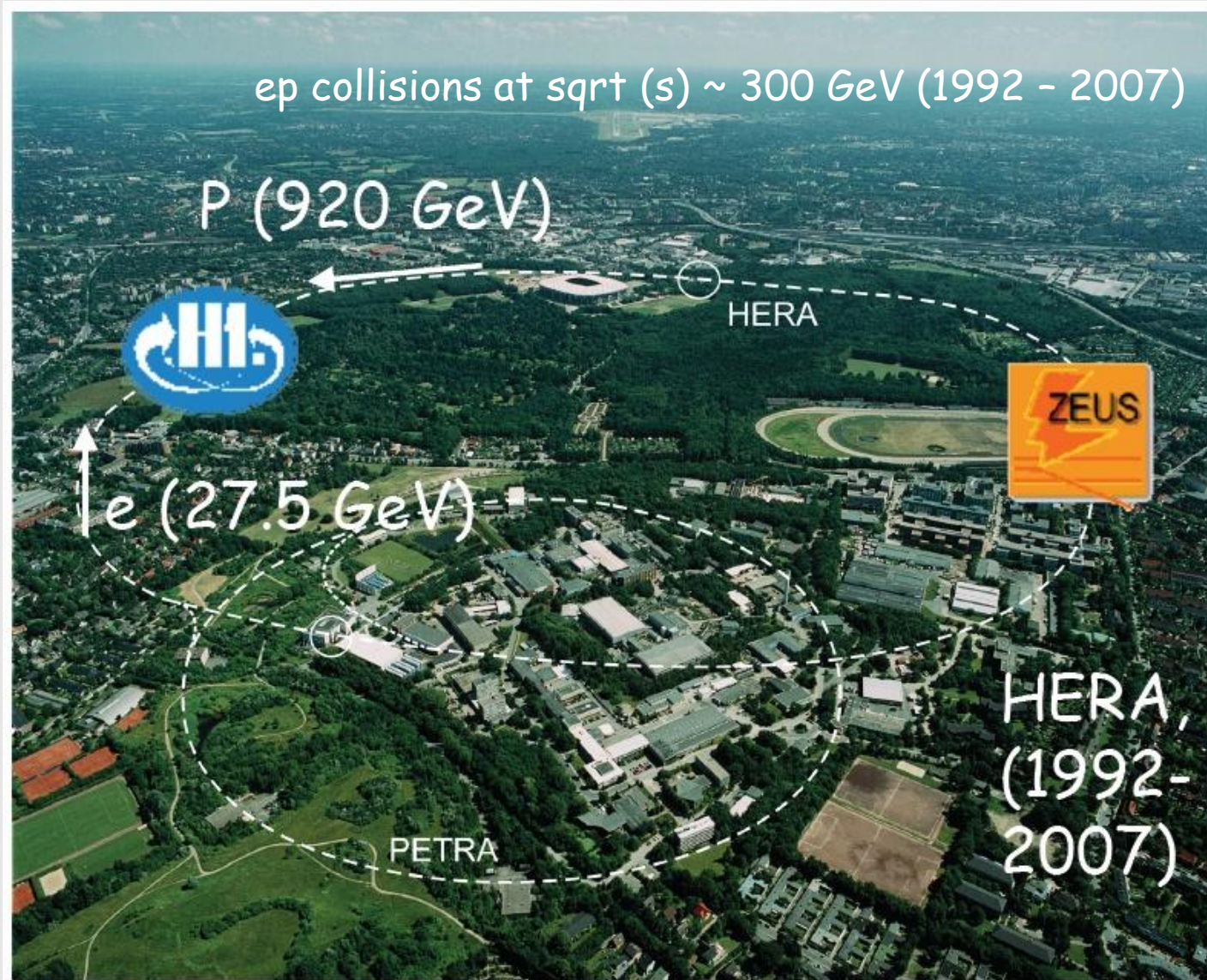

HERA experiments and diffraction

HERA: ~10% of low-x DIS events are diffractive

→ study QCD structure of high energy diffraction with virtual photon

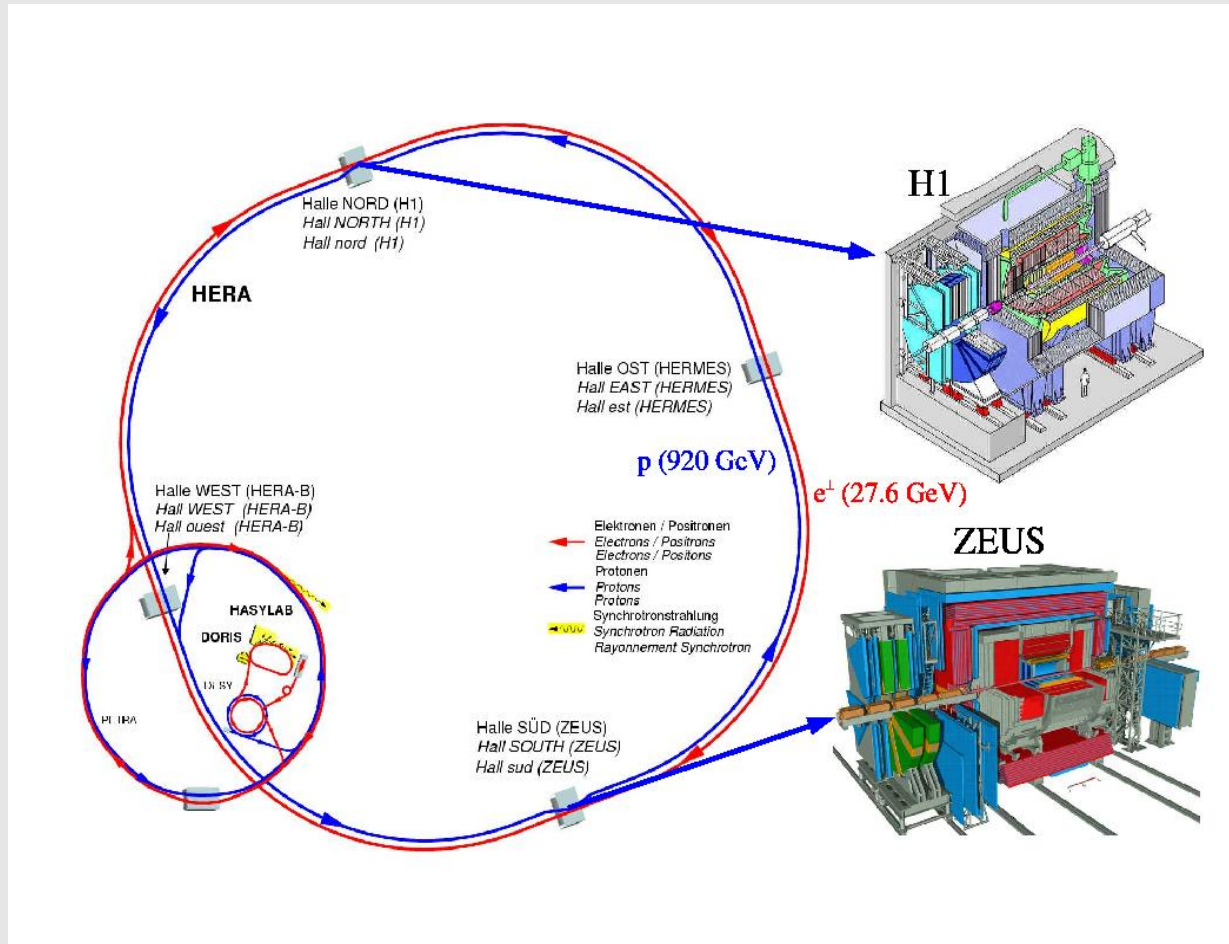

DEEP INELASTIC SCATTERING

- Scattering of a charged (neutral) lepton off a hadron at high momentum transfer

$$x = \frac{Q^2}{2P \cdot q} = \frac{Q^2}{Q^2 + W^2 - m_N^2}$$

Bjorken's x

- Measurement of the energy and scattering angle of the outgoing lepton

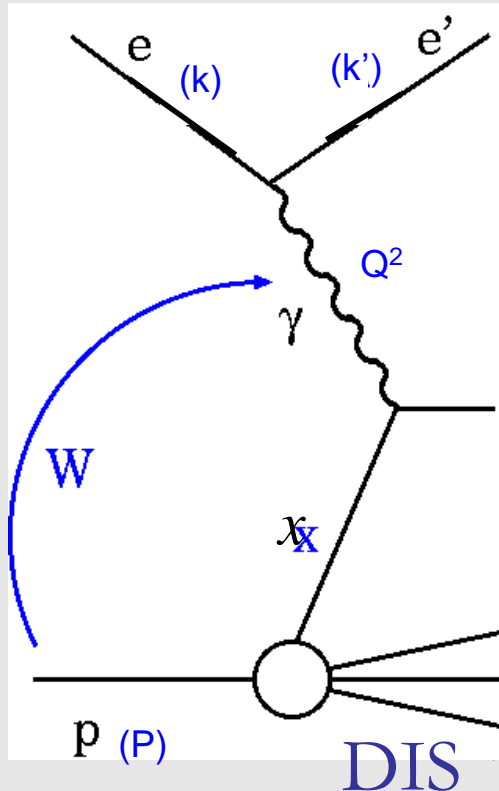

Inclusive DIS:
Probes partonic
structure of the
proton (F_2)

- ✓ Electron-proton centre of mass energy

$$s = (k + P)^2 \approx 4E_e E_p$$

- ✓ Photon virtuality

$$Q^2 = -q^2 = -(k - k')^2 \approx 4E_e E_e' \sin^2 \frac{\theta}{2}$$

- ✓ Photon-proton centre of mass energy

$$W^2 = (q + P)^2$$

- ✓ Square 4-momentum at the p vertex

$$t = (P' - P)^2 \quad 24$$

DEEP INELASTIC SCATTERING

- Introducing the hadronic tensor $W^{\mu\nu}$

$$W^{\mu\nu} = \frac{1}{2\pi} \int d^4 z e^{iq \cdot z} \langle N | J^\mu(z) J^\nu(0) | N \rangle$$

- Spin average absorbed in the nucleon state $|N\rangle$
- The leptonic tensor $L_{\mu\nu}$ defined as (lepton masses neglected)

$$L_{\mu\nu} = 2(l_\mu l'_\nu + l_\nu l'_\mu - g_{\mu\nu} l \cdot l')$$

- The differential cross section for DIS takes the form

$$\frac{d\sigma}{dE' d\Omega} = \frac{\alpha_{em}^2}{2m_N Q^4} \frac{E'}{E} L_{\mu\nu} W^{\mu\nu}$$

$$\Omega \equiv (\vartheta, \varphi)$$

Solid angle identifying the direction of the outgoing lepton

- It can be expressed in terms of two structure functions W_1 and W_2

$$\frac{d\sigma}{dE' d\Omega} = \frac{4\alpha_{em}^2 E'^2}{Q^4} \left[2W_1 \sin^2 \frac{\vartheta}{2} + W_2 \cos^2 \frac{\vartheta}{2} \right]$$

DEEP INELASTIC SCATTERING

- Introducing the dimensionless structure functions

$$F_1(x, Q^2) \equiv m_N W_1(\nu, Q^2)$$

$$\nu = \frac{W^2 + Q^2 - m_N^2}{2m_N}$$

$$F_2(x, Q^2) \equiv \nu W_1(\nu, Q^2)$$

- The hadronic tensor in terms of F_1 and F_2 reads

$$W_{\mu\nu} = 2 \left(-g_{\mu\nu} + \frac{q_\mu q_\nu}{q^2} \right) F_1(x, Q^2) + \frac{2}{(P \cdot q)} \left[\left(P_\mu - \frac{P \cdot q}{q^2} q_\mu \right) \left(P_\nu - \frac{P \cdot q}{q^2} q_\nu \right) \right] F_2(x, Q^2)$$

- The differential cross section for DIS takes the form

$$\frac{d\sigma}{dx dy} = \frac{4\pi\alpha_{em}^2 s}{Q^4} \left\{ xy^2 F_1(x, Q^2) + \left(1 - y - \frac{xy m_N^2}{s} \right) F_2(x, Q^2) \right\}$$

$$F_T = 2xF_1$$

$$\sigma^{\gamma^* N}(x, Q^2) = \frac{4\pi^2 \alpha_{em}}{Q^2} F_2(x, Q^2)$$

$$F_L = F_2 - 2xF_1$$

DIFFRACTIVE DIS

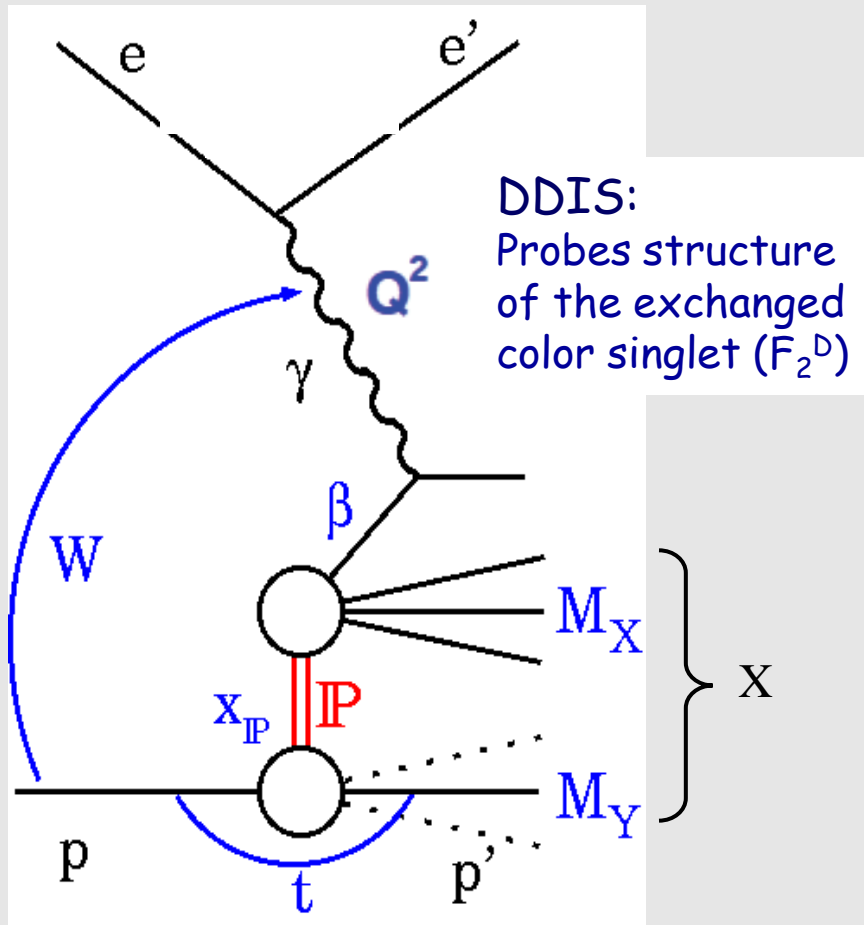

DDIS

- ✓ Proton escapes in the beam pipe
- ✓ no quantum numbers exchanged between γ^* and p

NO COLOUR FLUX

LARGE RAPIDITY GAP

- ✓ pQCD motivated description of strong interactions

Kinematics of DDIS

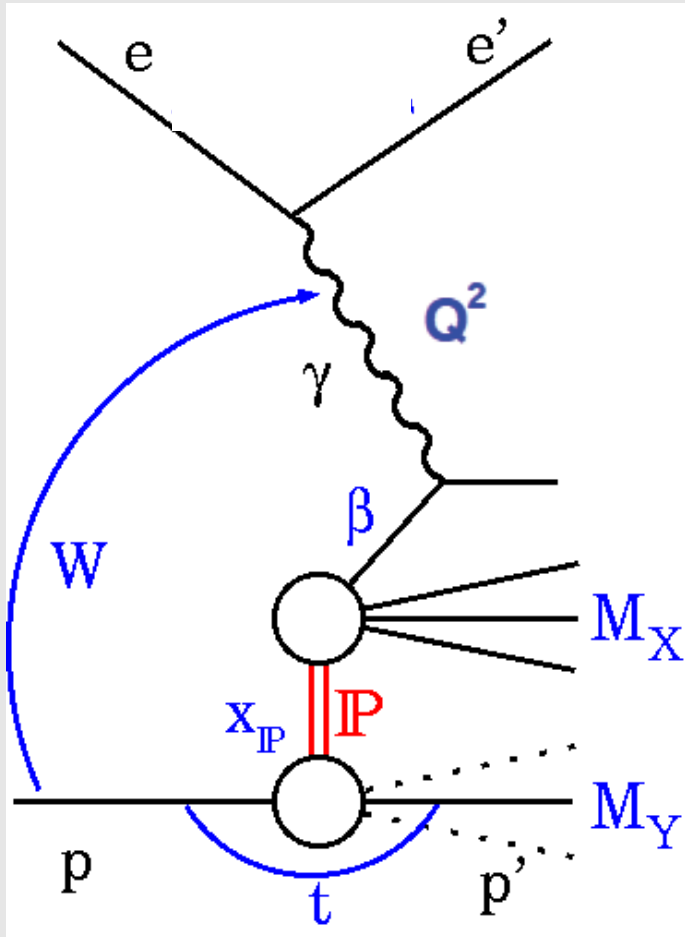

DDIS

✓ Described by 5 kinematical variables

✓ Two are the same appearing in DIS:

➤ Bjorken's x

$$x = \frac{Q^2}{2P \cdot q} = \frac{Q^2}{W^2 + Q^2 - m_N^2} \approx \frac{Q^2}{W^2 + Q^2}$$

➤ Squared momentum transfer at the lepton vertex

$$Q^2 = -q^2 = -(k - k')^2$$

or

$$y = \frac{P \cdot q}{P \cdot k} \approx \frac{Q^2}{xs}$$

Kinematics of DDIS

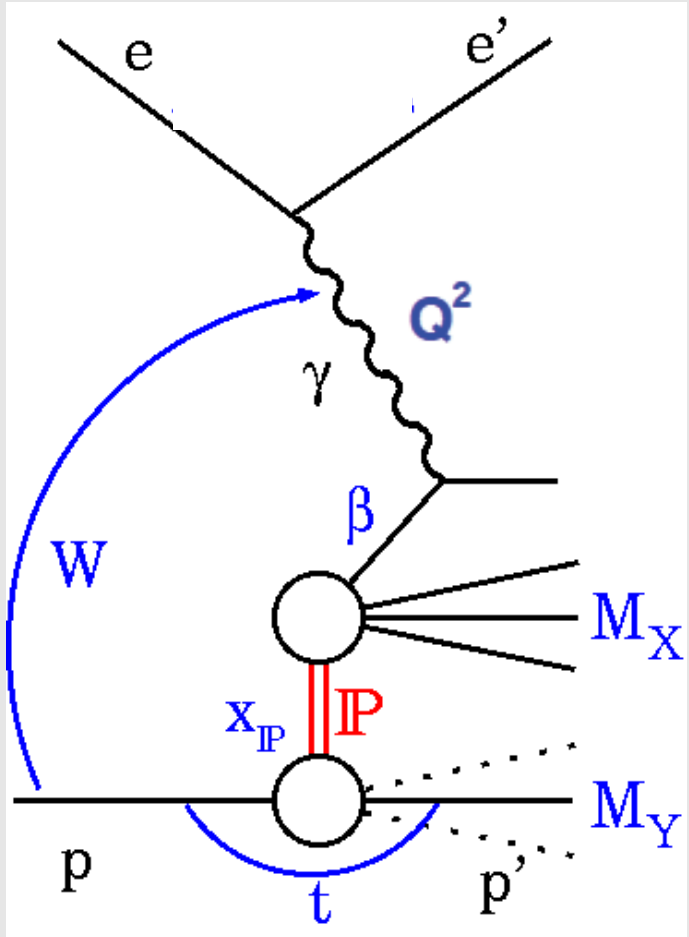

DDIS

✓ New kinematic variables are dependent of the three-momentum P' of the outgoing proton

✓ Invariant quantities $t = -(P' - P)^2 \approx -\frac{P'^2_{\perp}}{x_F}$

$$x_{IP} = \frac{(P - P') \cdot q}{P \cdot q} = \frac{M^2 + Q^2 - t}{W^2 + Q^2 - m_N^2} \approx \frac{M^2 + Q^2}{W^2 + Q^2} = 1 - x_F$$

✓ M^2 is the invariant mass of the X system

✓ x_F is the Feynman variable

$$x_F \equiv \frac{|p'_z|}{p_z}$$

✓ β is the momentum fraction of the parton inside the Pomeron

$$\beta = \frac{Q^2}{2q \cdot (P - P')} = \frac{Q^2}{M^2 + Q^2 - t} \approx \frac{Q^2}{M^2 + Q^2}$$

Diffractive Structure Functions

- ✓ DDIS differential cross section can be written in terms of two structure functions

$$F_1^{D(4)} \quad \text{and} \quad F_2^{D(4)}$$

- ✓ Dependence of variables $\longrightarrow x, Q^2, x_{IP}, t$

- ✓ Introducing the longitudinal and transverse diffractive structure functions

$$F_L^{D(4)} = F_2^{D(4)} - 2xF_1^{D(4)}$$

$$F_T^{D(4)} = 2xF_1^{D(4)}$$

- ✓ DDIS cross section is

$$\frac{d\sigma_{\gamma^* p}^D}{dx dQ^2 dx_{IP} dt} = \frac{4\pi\alpha_{em}^2}{xQ^4} \left\{ 1 - y + \frac{y^2}{2[1 + R^{D(4)}(x, Q^2, x_{IP}, t)]} \right\} F_2^{D(4)}(x, Q^2, x_{IP}, t)$$

- ✓ $R^{D(4)} = \frac{F_L^{D(4)}}{F_T^{D(4)}}$ is the longitudinal-to-transverse ratio

Diffractive Structure Functions

✓ Data are taken predominantly at small y

✓ Cross section \longrightarrow little sensitivity to $R^{D(4)}$

✓ $F_L^{D(4)} \ll F_T^{D(4)}$ for $\beta < 0.8 - 0.9$ \longrightarrow neglect $R^{D(4)}$ at this range

$$\frac{d\sigma_{\gamma^* p}^D}{dx dQ^2 dx_{IP} dt} = \frac{4\pi\alpha_{em}^2}{xQ^4} \left(1 - y + \frac{y^2}{2}\right) F_2^{D(4)}(x, Q^2, x_{IP}, t)$$

✓ $F_2^{D(4)}$ \longrightarrow proportional to the cross section for diffractive γ^*p scattering

$$F_2^{D(4)}(x, Q^2, x_{IP}, t) = \frac{Q^2}{4\pi\alpha_{em}^2} \frac{d\sigma_{\gamma^* p}^D}{dx_{IP} dt}$$

✓ $F_2^{D(4)}$ \longrightarrow dimensional quantity

$$F_2^{D(4)} \equiv \frac{dF_2^D(x, Q^2, x_{IP}, t)}{dx_{IP} dt}$$

F_2^D is dimensionless

Diffractive Structure Functions

- ✓ When the outgoing proton is not detected

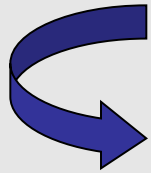

no measurement of t

- ✓ Only the cross section integrated over t is obtained

$$\frac{d\sigma_{\gamma^* p}^D}{dx dQ^2 dx_{IP}} = \frac{4\pi\alpha_{em}^2}{xQ^4} \left(1 - y + \frac{y^2}{2}\right) F_2^{D(3)}(x, Q^2, x_{IP})$$

- ✓ The structure function $F_2^{D(4)}$ is defined as

$$F_2^{D(3)}(x, Q^2, x_{IP}) = \int_0^\infty d|t| F_2^{D(4)}(x, Q^2, x_{IP}, t)$$

Diffractive Parton Distributions

- ✓ Factorization theorem holds for diffractive structure functions
- ✓ These can be written in terms of the diffractive partons distributions
- ✓ It represents the **probability to find a parton** in a hadron h , under the condition the h undergoes a diffractive scattering

- ✓ QCD factorization formula for F_2^D is

$$\frac{dF_2^D(x, Q^2, x_{IP}, t)}{dx_{IP} dt} = \sum_i \int_x^{x_{IP}} d\xi \frac{df_i(\xi, \mu^2, x_{IP}, t)}{dx_{IP} dt} \hat{F}_2^i\left(\frac{x}{\xi}, Q^2, \mu^2\right)$$

- ✓ $df_i(\xi, \mu^2, x_{IP}, t) / dx_{IP} dt$ is the diffractive distribution of parton i
- ✓ Probability to find in a proton a parton of type i carrying momentum fraction ξ
- ✓ Under the requirement that the **proton remains intact** except for a momentum transfer quantified by x_{IP} and t

Diffractive Parton Distributions

- ✓ Perturbatively calculable coefficients

$$\hat{F}_2^i \left(\frac{x}{\xi}, Q^2, \mu^2 \right)$$

- ✓ Factorization scale $\longrightarrow \mu^2 = M^2$

- ✓ Diffractive parton distributions satisfy DGLAP equations

- ✓ Thus

$$\frac{\partial}{\partial \ln \mu^2} \frac{df_i(\xi, \mu^2, x_{IP}, t)}{dx_{IP} dt} = \sum_j \int_{\xi}^1 \frac{d\zeta}{\zeta} P_{ij} \left(\frac{\xi}{\zeta}, \alpha_s(\mu) \right) \frac{df_j(\xi, \mu^2, x_{IP}, t)}{dx_{IP} dt}$$

- ✓ “fracture function” is a diffractive parton distribution integrated over t

$$\frac{df_i(\xi, \mu^2, x_{IP})}{dx_{IP}} = \int_{\frac{x_{IP}^2 m_N^2}{1-x_{IP}}}^{\infty} d|t| \frac{df_i(\xi, \mu^2, x_{IP}, t)}{dx_{IP} dt}$$

Partonic Structure of the Pomeron

- ✓ It is quite usual to introduce a partonic structure for F_2^{IP}
- ✓ At Leading Order \longrightarrow Pomeron Structure Function written as a **superposition** of quark and antiquark distributions in the Pomeron

$$F_2^{IP}(\beta, Q^2) = \sum_{q, \bar{q}} e_q^2 \beta q^{IP}(\beta, Q^2)$$

- ✓ $\beta = \frac{x}{x_{IP}}$ \longrightarrow interpreted as the **fraction of the Pomeron momentum** carried by its partonic constituents
- ✓ $q^{IP}(\beta, Q^2)$ \longrightarrow probability to **find a quark** q with momentum fraction β inside the Pomeron

- ✓ This interpretation makes sense only if we can specify unambiguously the probability of finding a Pomeron in the proton and assume the Pomeron to be a real particle (INGELMAN-SCHLEIN / 1985)

Partonic Structure of the Pomeron

✓ Diffractive **quark distributions** and **quark distributions of the Pomeron** are related

$$\frac{df_q(\beta, Q^2, x_{IP}, t)}{dx_{IP}dt} = \frac{1}{16\pi^2} |g_{IP}(t)|^2 x_{IP}^{-2\alpha_{IP}(t)} q^{IP}(\beta, Q^2)$$

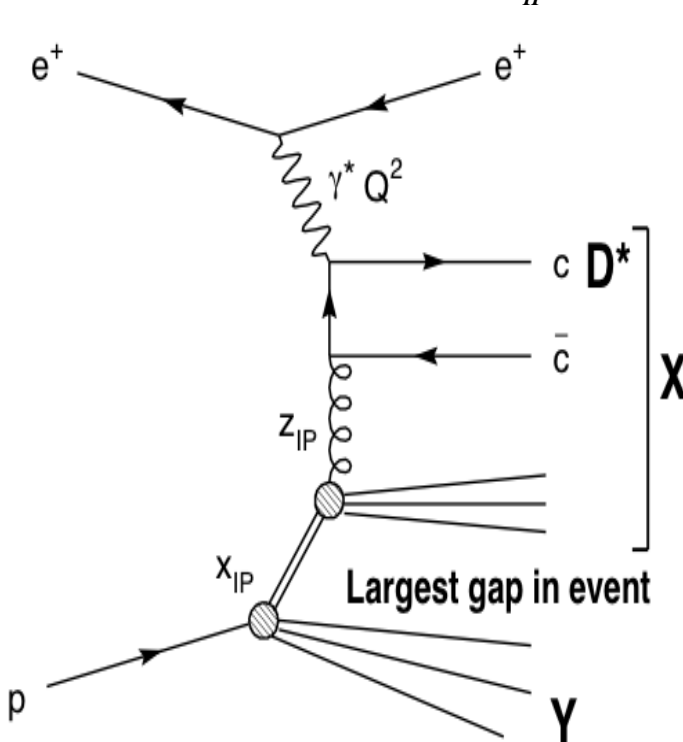

Representation of D^* diffractive production in the infinite-momentum frame description of DDIS

- Introducing gluon distribution in the Pomeron

$$g^{IP}(\beta, Q^2)$$

- Related to $df_g / dx_{IP}dt$ by

$$\frac{df_g(\beta, Q^2, x_{IP}, t)}{dx_{IP}dt} = \frac{1}{16\pi^2} |g_{IP}(t)|^2 x_{IP}^{-2\alpha_{IP}(t)} g^{IP}(\beta, Q^2)$$

- At Next-to-Leading order, **Pomeron Structure Function** acquires a term containing $g^{IP}(\beta, Q^2)$

QCD factorization

PDFs from inclusive diffraction predict cross sections for exclusive diffraction

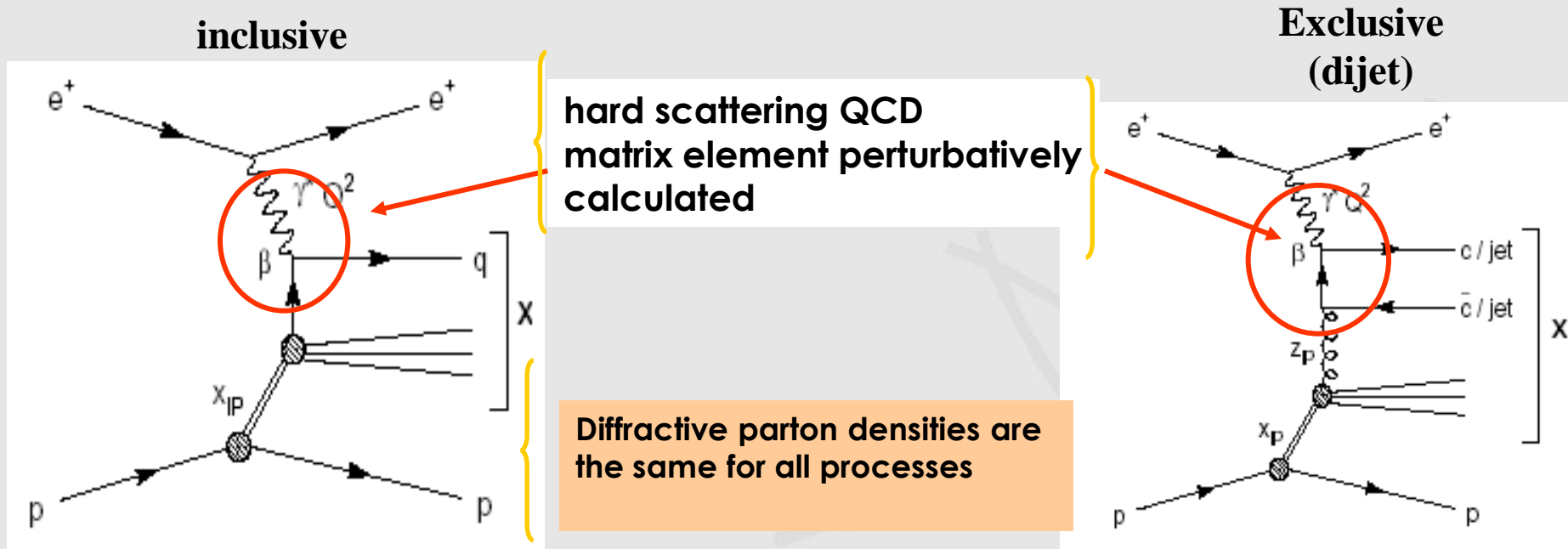

$$\sigma^D(\gamma^* p \rightarrow Xp) = \sum_{parton_i} f_i^D(x, Q^2, x_{IP}, t) \cdot \sigma^{\gamma^*i}(x, Q^2)$$

σ^{γ^*i} \longrightarrow universal hard scattering cross section (same as in inclusive DIS)

f_i^D \longrightarrow diffractive parton distribution functions \rightarrow obey DGLAP
universal for diffractive ep DIS (inclusive, di-jets, charm)

Analysis of F_2^D (β, Q^2)

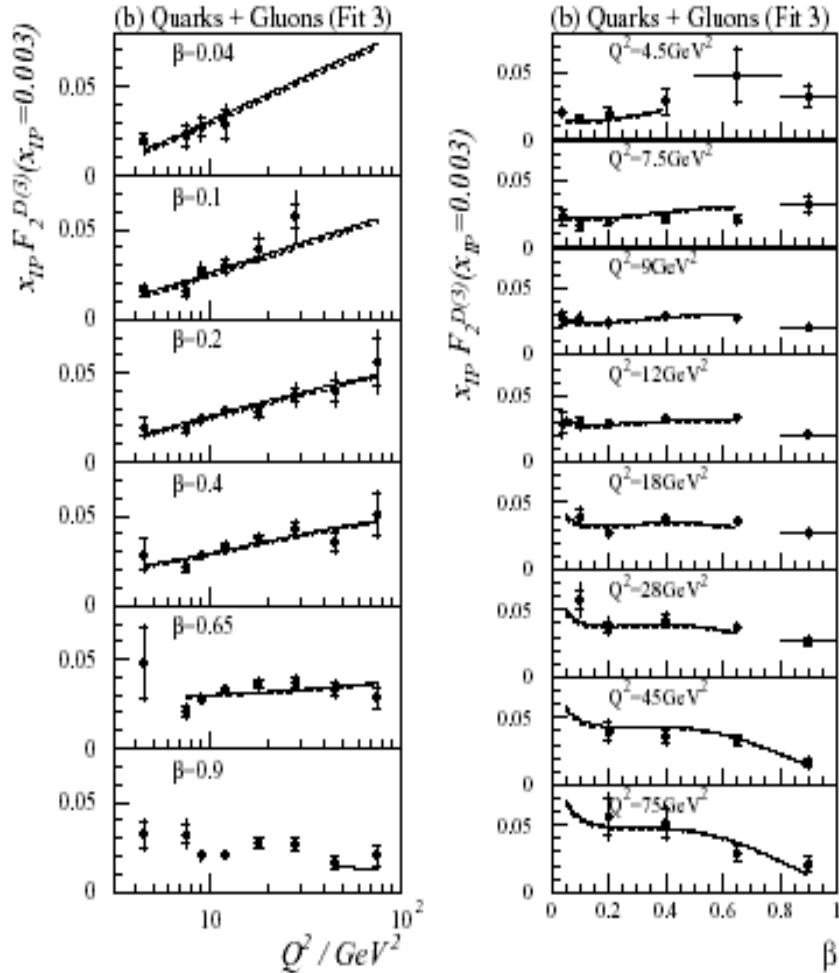

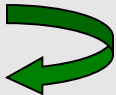
✓ Hard partons in IP 
 weak β dependence

✓ QCD evolution 
 weak $\log Q^2$ dependence

✓ Scattering on point-like charges 
 approximate scaling

$$F_2^{IP}(\beta) = F_2^{D(4)} / f_{IP/p} \approx \frac{x}{\beta} F_2^{D(4)}(x)$$

Results from inclusive diffraction (2002)

$$f_i^D(x, Q^2, x_{IP}, t) = f_{IP/p}(x_{IP}, t) \cdot f_i^{IP}(\beta = x/x_{IP}, Q^2)$$

pomeron flux factor

pomeron PDF

$$\sigma^{diff} = flux(x_P) \cdot \hat{\sigma}(\beta, Q^2)$$

$$f_{IP/p}(x_{IP}, t) = A_{IP} \frac{e^{B_{IP}t}}{x_{IP}^{2\alpha_{IP}(t)-1}}$$

A_{IP} and B_{IP} parameters

$\hat{\sigma}$ → Partonic cross section

Reduced cross section from inclusive diffractive data

$$\sigma_r^{D(3)}(\beta, Q^2, x_{IP}) \approx F_2^{D(3)}$$

- get diffractive PDFs from a **NLO (LO) DGLAP QCD Fit** to inclusive data from 6.5 GeV² to 120 GeV²

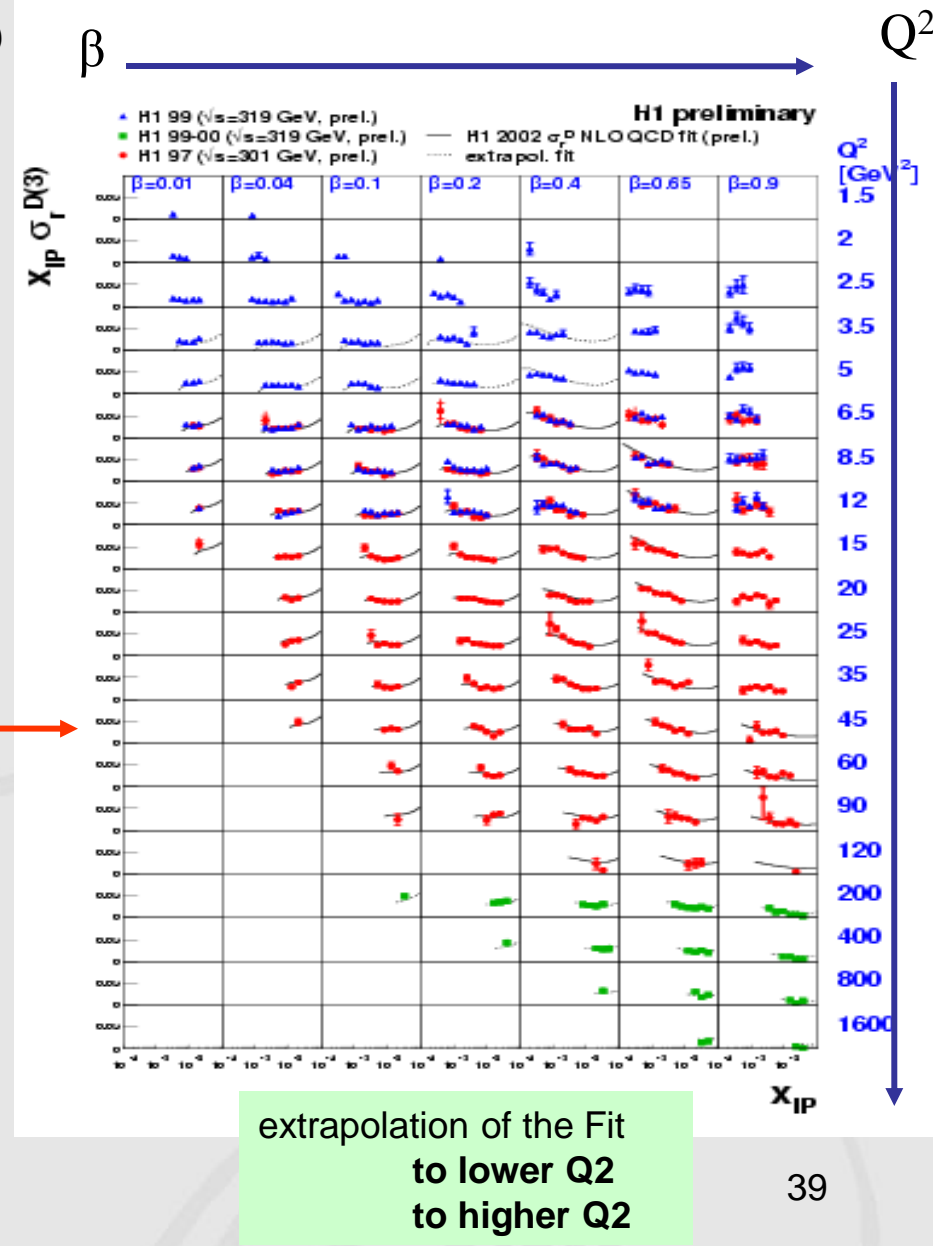

Results from inclusive diffraction (2008)

$$3.5 \leq Q^2 \leq 1600 \text{ GeV}^2$$

Gives a reasonably good description of inclusive data from
3.5 GeV² – 1600 GeV²

Data on low β for high Q^2

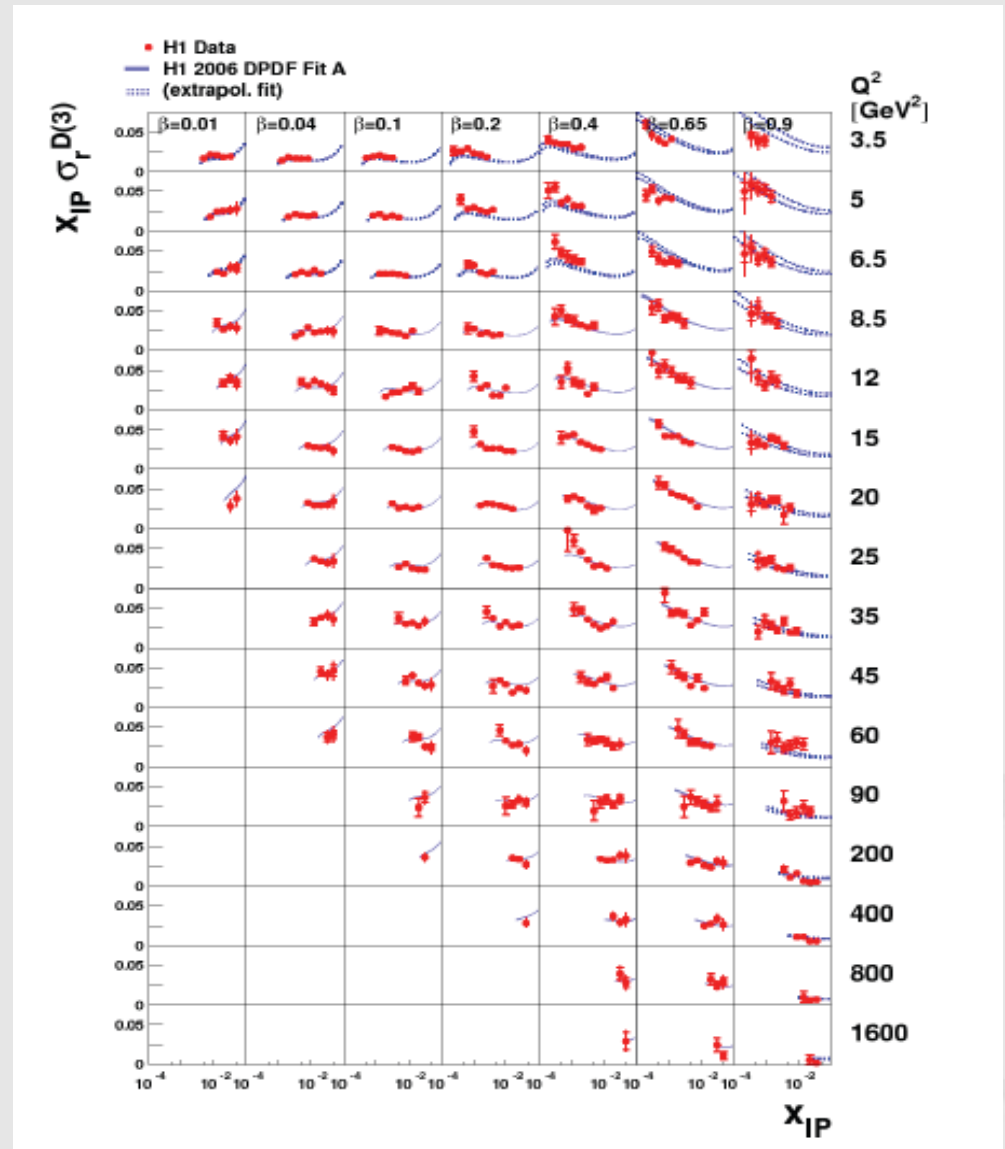

Diffractive Parton Densities (H1-02)

- Determined from NLO QCD analysis of diffractive structure function
- More sensitive to quarks
- Gluons from scaling violation, poorer constraint
- Gluon carries about 75% of pomeron momentum
- Large uncertainty at large z_P

If factorisation holds, jet and HQ cross sections give better constraint on the gluon density

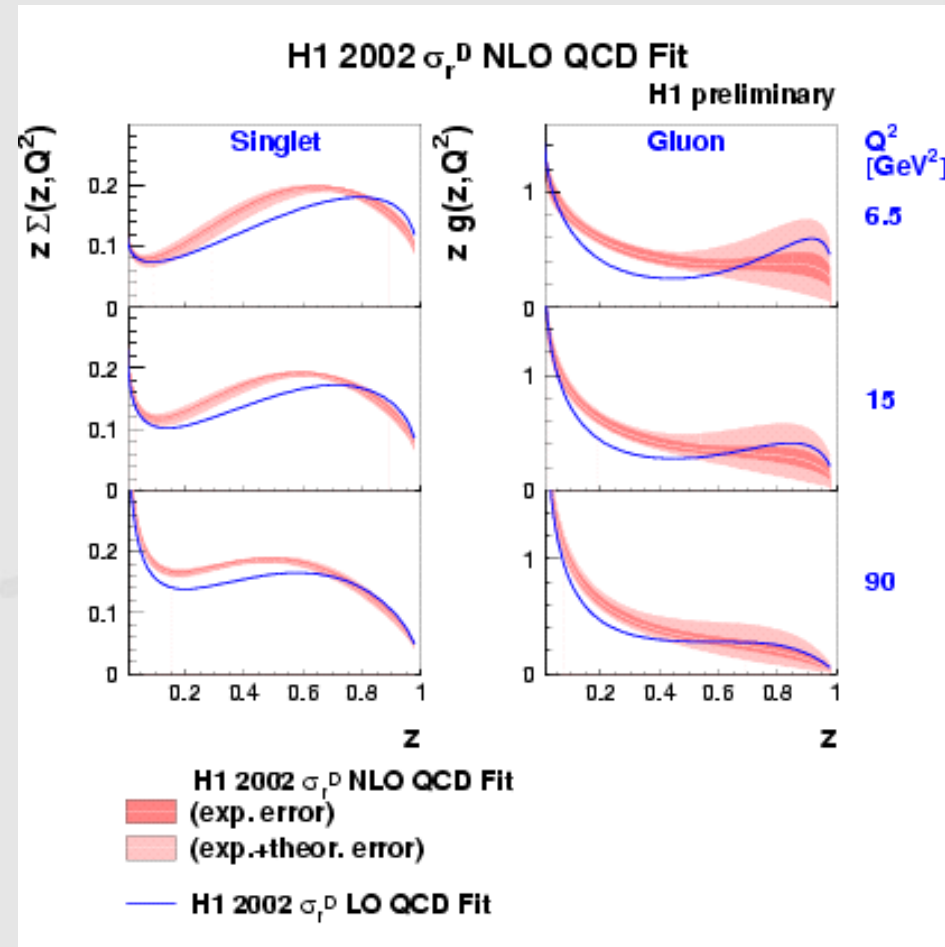

Diffractive Parton Densities (H1-06)

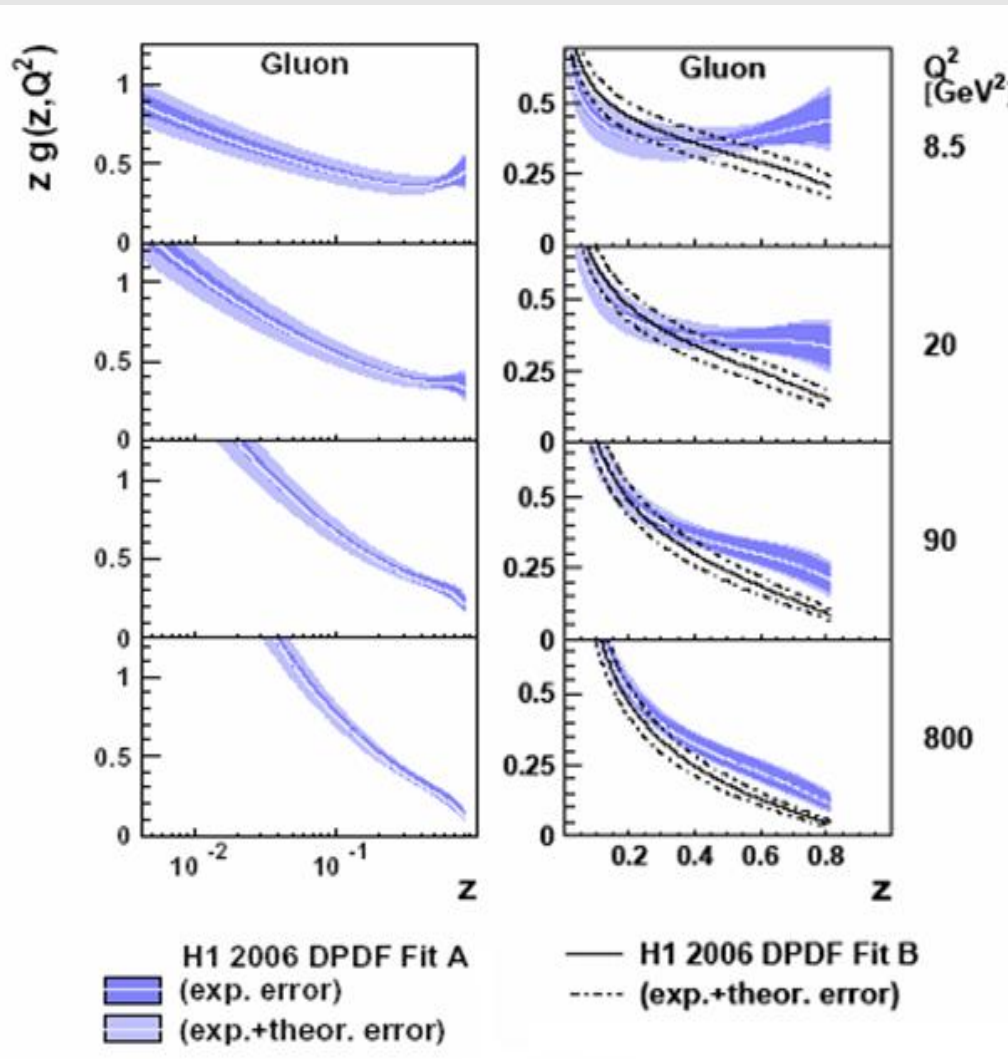

- Total quark singlet and gluon distributions obtained from NLO QCD H1. DPDF Fit A,

- Range $0.0043 < z < 0,8$, corresponding to experiment

- Central lines surrounded by inner

errors bands

experimental uncertainties

- Outer error bands

experimental and theoretical uncertainties

z is the momentum fraction of the parton inner the Pomeron

Diffractive Parton Densities (ZEUS-06)

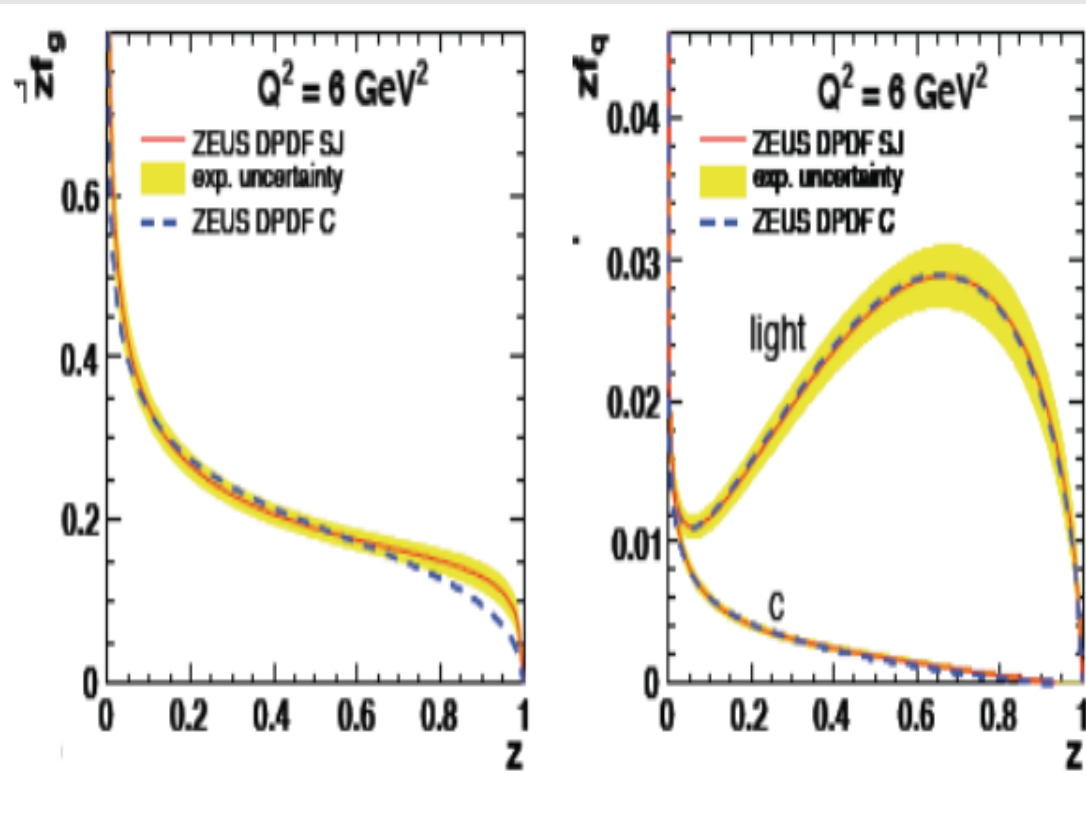

✓ Recent Zeus fits to higher statistical large rapidity gaps

✓ Improved heavy flavour treatment

✓ DPDFs dominated by gluon density

✓ It extends to large z

DIFFRACTION AT TEVATRON

TEVATRON

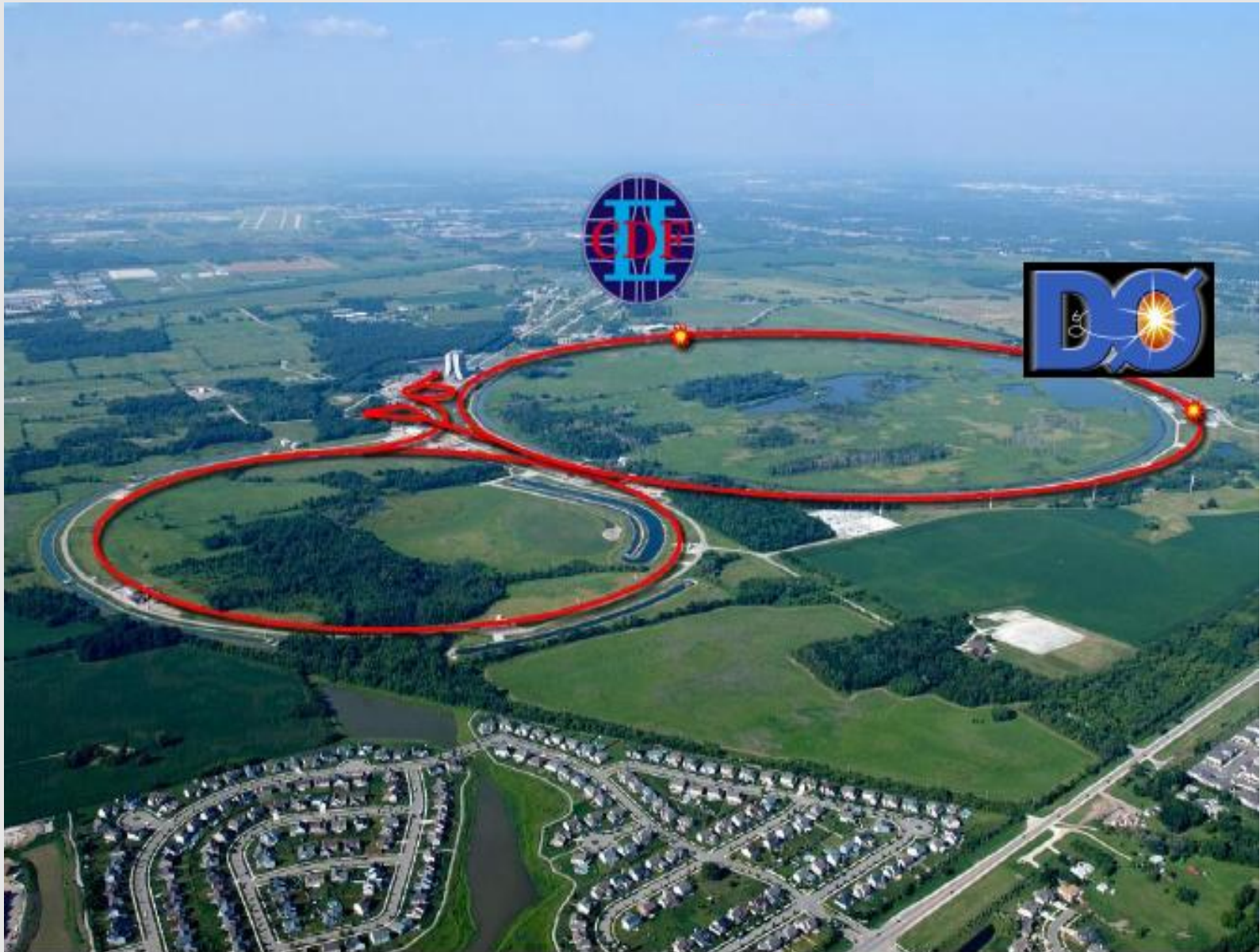

Diffraction at Tevatron

- Proton-antiproton scattering at highest energy
- Soft & Hard Diffraction

$\xi < 0.1 \Rightarrow O(1)$ TeV "Pomeron beams"

Structure function of the Pomeron
 $F(\beta, Q^2)$

Diffraction dynamics?
 Exclusive final states ?

- Gap dynamics in pp presently not fully understood!

$$\xi = M_X^2 / s$$

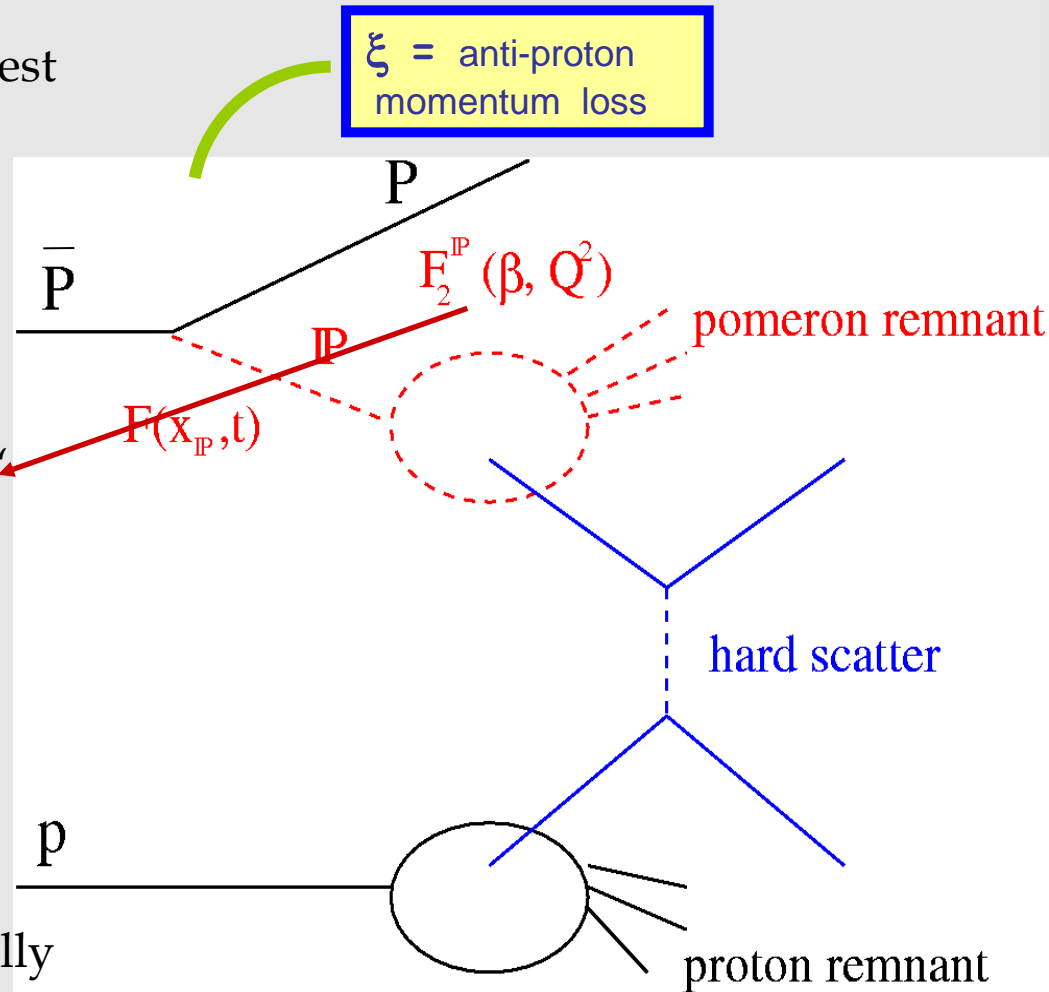

Diffraction at Tevatron

- IS paper (1985) \longrightarrow first discussion of high- p_T jets produced via Pomeron exchange
- Events containing **two jets** of high transverse energy and a **leading proton** were observed in proton-antiproton scattering at $\sqrt{s} = 630$ GeV by the **CERN UA8 experiment** (Bonino et al. 1988)
- Rate of jet production in this scattering \longrightarrow 1 - 2%
- It was in **agreement** with the predicted order of magnitude made by IS
- Since then \longrightarrow hard diffraction in **proton-proton scattering** was pursued by the CDF and D0 Collaborations at the Tevatron
- UA8 group reported some **evidence** for a **hard Pomeron substructure** $\beta(1-\beta)$ (Brand et al. 1992)

Diffraction at Tevatron

- Kinematical range for physical process at Tevatron \longrightarrow broader
- Experiments have been **investigating** diffractive reactions
- First results of diffractive events were **reported in 1994-1995** (Abachi et al. 1994; Abe et al. 1995)
- Then, **three** different classes of **processes** investigated at the Tevatron

Double diffraction

Single diffraction

Double Pomeron Exchange

- Both CDF and D0 detectors covered the **pseudorapidity range**

$$|\eta| \leq 4 - 5$$

Diffractive Physics at 1.96 TeV

- ❖ Physics observed at the Tevatron described by colour exchange perturbative QCD
- ❖ There is also **electroweak physics** on a somewhat smaller scale
- ❖ There is a **significant amount of data** that is not described by colour exchange perturbative interaction

WHAT IS
HAPPENING?

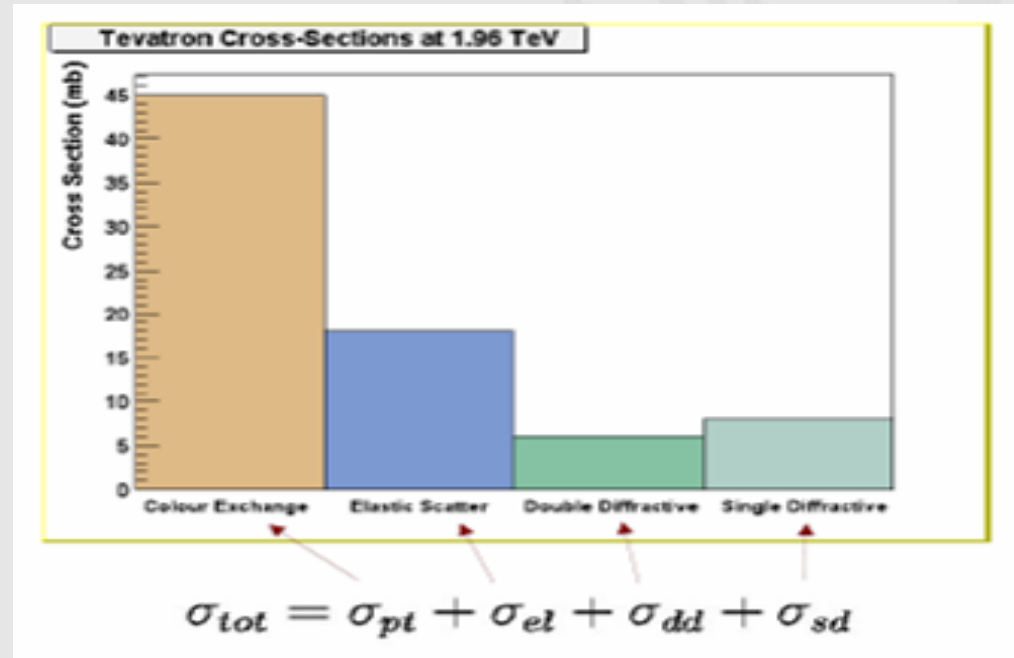

Hard Single diffraction

- Large rapidity gap
- Intact hadrons detected

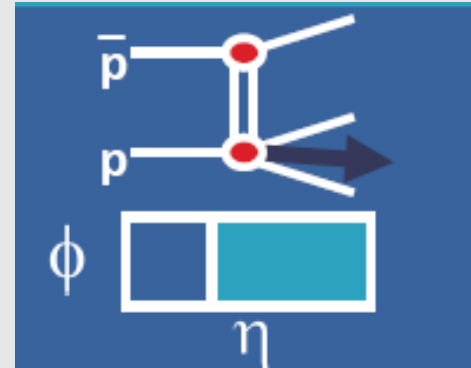

- Diffractive production of some objects can be studied

Jets, W, J/ψ, b ...

- Measurement of the ratio of diffractive to non-diffractive production

Hard component	Fraction (R) %
Dijet	0.75 ± 0.10
W	1.15 ± 0.55
b	0.62 ± 0.25
J/ψ	1.45 ± 0.25

All fractions

~ 1%

Hadronic case

To calculate diffractive hard processes at the Tevatron

- Using diffractive parton densities from HERA
- Obtain cross sections one order of magnitude higher

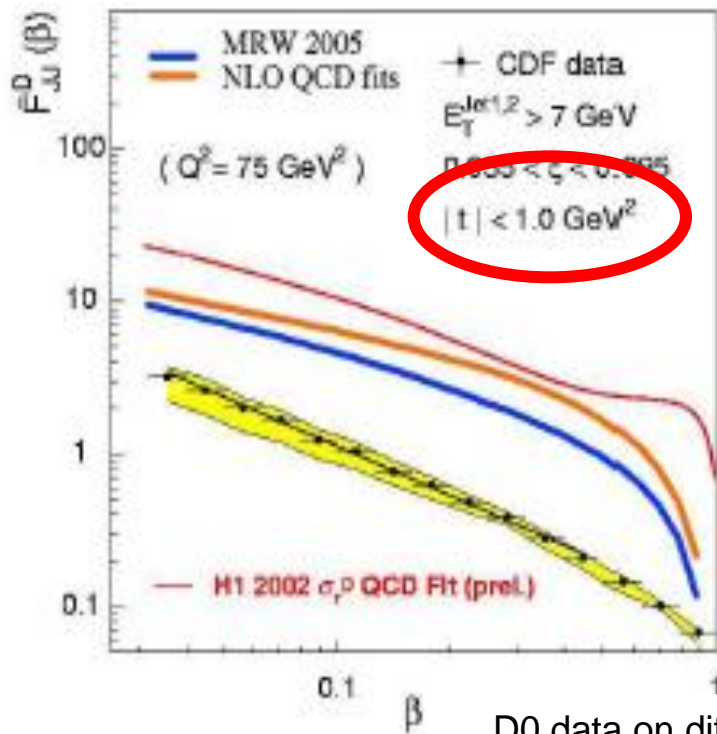

2002

- IP approach

IP parton densities

IP flux

Universal?

- IP an effect from QCD dynamics?

D0 data on diffractive dijets

Hadronic case

2006

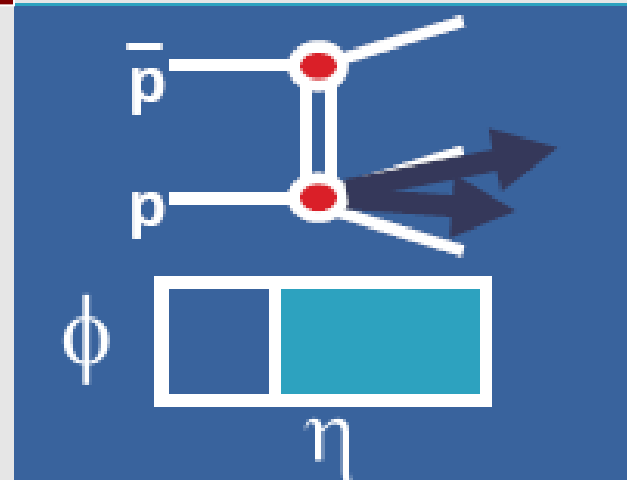
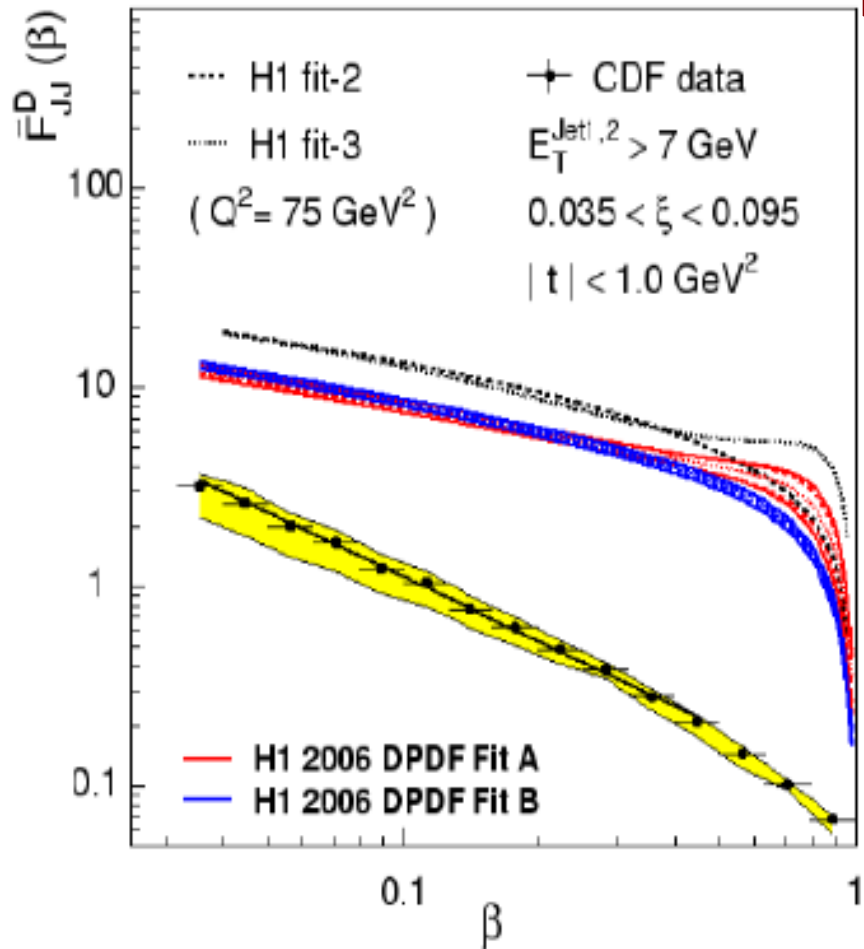

Factorization breakdown
between HERA and Tevatron

IS doesn't describe DATA
diffractive cross section



Momentum fraction of parton in the Pomeron

Pomeron as composite

- Considering Regge factorization we have

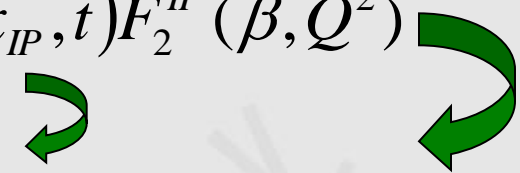

$$F_2^{D(4)}(x, Q^2, x_{IP}, t) = f_{IP/p}(x_{IP}, t) F_2^{IP}(\beta, Q^2)$$

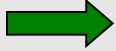

see MBGD & M. V. T. Machado 2001

Data  Good fit with added Reggeon for HERA

Pomeron as gluons

- Elastic amplitude  neutral exchange in t-channel
- Smallness of the real part of the diffractive amplitude  nonabeliance

Born graphs in the abelian and nonabelian (QCD) cases look like

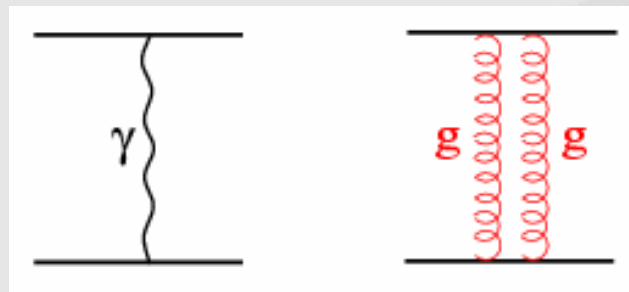

Diffractive dijet cross section

$$\sigma(\bar{p}p \rightarrow \bar{p}X) \approx F_{jj} \otimes F_{jj}^D \otimes \hat{\sigma}(ab \rightarrow jj)$$

- ❖ Study of the diffractive structure function

$$F_{jj}^D = F_{jj}^D(x, Q^2, t, \xi)$$

- ❖ Experimentally determine diffractive structure function

$$R_{\frac{SD}{ND}}(x, \xi) = \frac{\sigma(SD_{jj})}{\sigma(ND_{jj})} = \frac{F_{jj}^D(x, Q^2, \xi)}{F_{jj}(x, Q^2)}$$

DATA



KNOWN PDF

Will factorization hold at Tevatron?

Gap Survival Probability (GSP)

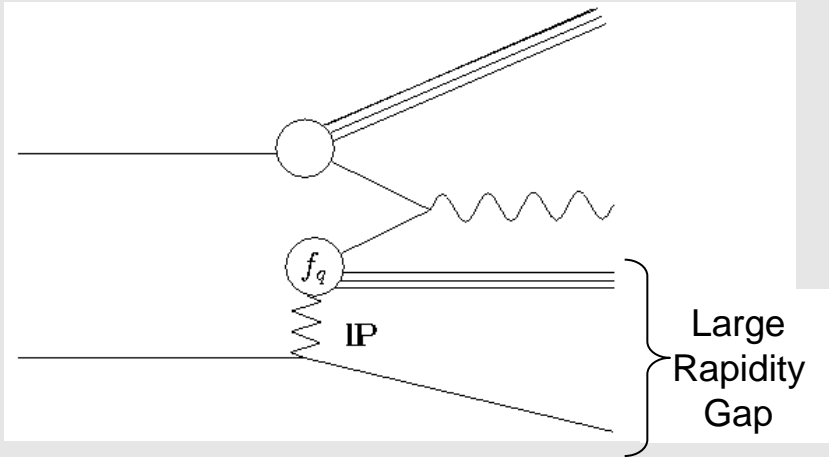

GAP



region of angular phase space
devoid of particles

Survival probability



fulfilling of the gap by hadrons
produced in interactions of
remanescent particles

$$\langle |S| \rangle^2 = \frac{\int d^2b |A(s,b)|^2 P^S(s,b)}{\int d^2b |A(s,b)|^2}$$

- $A(s,b)$ → amplitude of the particular process (parameter space b)
of interest at center-of-mass energy \sqrt{s}

- $P^S(s,b)$ → probability that **no inelastic interaction occurs** between scattered hadrons

KMR – Gap Survival Probability

Khoze-Martin-Ryskin Eur. Phys. J. C. 26 229 (2002)

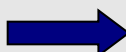
- Survival probability of the rapidity gaps
- Associated with the Pomeron (double vertical line)
 - Calculated
 - * single diffraction (SD)
 - * central diffraction (CD)
 - * double diffraction (DD)
- FPS (cal)  forward photon spectrometer (calorimeter),
- Detection of isolated protons (events where leading baryon is either a proton or a N*)

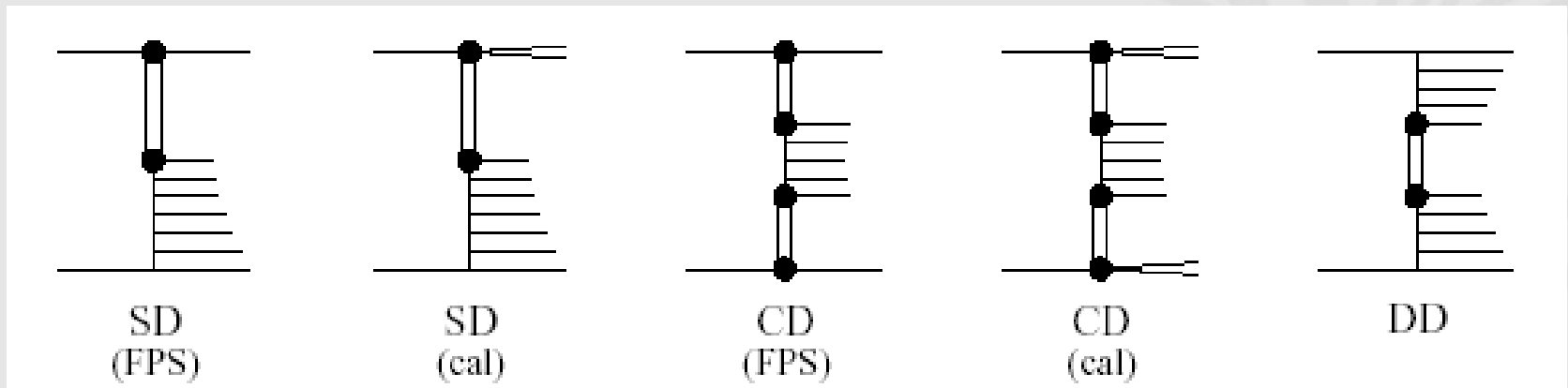

KMR model

- **t dependence** of elastic pp differential cross section in the form $\exp(Bt)$
- **Pion-loop insertions** in the Pomeron trajectory
- **Non-exponential form** of the proton-Pomeron vertex $\beta(t)$
- **Absorptive corrections**, associated with **eikonalization**

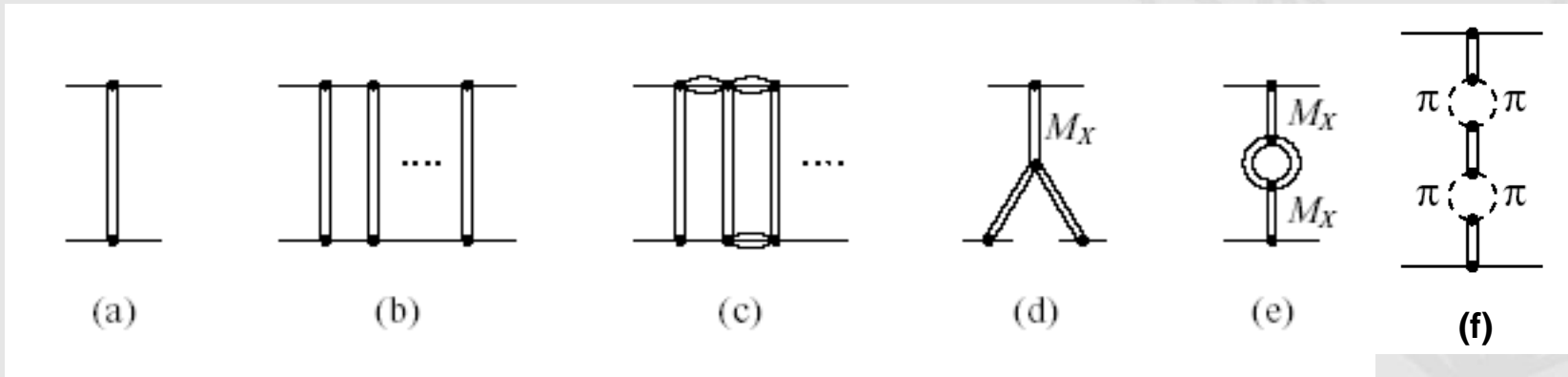

- (a) Pomeron exchange contribution;
- (b-e) Unitarity corrections to the pp elastic amplitude.
- (f) Two pion-loop insertion in the Pomeron trajectory

KMR model

- GSP KMR values

\sqrt{s} (TeV)	$2b$ (GeV ⁻²)	Survival probability S^2 for:				
		SD (FPS)	SD (cal)	CD (FPS)	CD (cal)	DD
0.54	4.0	0.14	0.13	0.07	0.06	0.20
	5.5	0.20	0.18	0.11	0.09	0.26
	7.58	0.27	0.25	0.16	0.14	0.34
1.8	4.0	0.10	0.09	0.05	0.04	0.15
	5.5	0.15	0.14	0.08	0.06	0.21
	8.47	0.24	0.23	0.14	0.12	0.32
14	4.0	0.06	0.05	0.02	0.02	0.10
	5.5	0.09	0.09	0.04	0.03	0.15
	10.07	0.21	0.20	0.11	0.09	0.29

- GSP considering multiple channels

GLM - GSP

Gotsman-Levin-Maor PLB 438 229 (1998 - 2002)

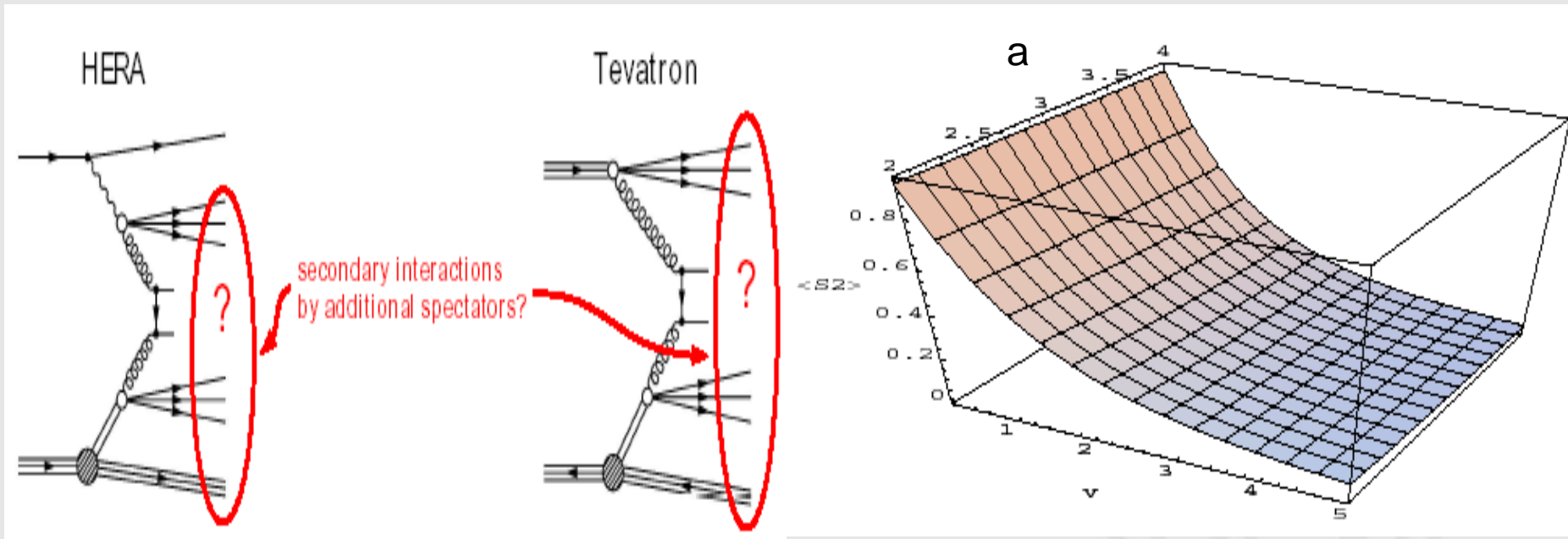

- Survival probability as a function of Ω ($s, b = 0$)
- Ω \longrightarrow opacity (optic density) of interaction of incident hadrons
- Ratio of the radius in soft and hard interactions $\longrightarrow a = R_s / R_h$
- Suppression due to secondary interactions by additional spectators hadrons

GLM model

GLM - arXiv:hep-ph/0511060v1 6 Nov 2005

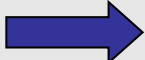
- Eikonal model originally  explain the exceptionally mild energy dependence of soft diffractive cross sections
- s-channel unitarization enforced by the eikonal model
- Operates on a diffractive amplitude in different way than elastic amplitude
- Soft input obtained directly from the measured values of σ_{tot} , σ_{el} and hard radius R_H
- *F1C* and *D1C*  different methods from GLM model

\sqrt{s} (GeV)	$S_{CD}^2(F1C)$	$S_{CD}^2(D1C)$	$S_{SD_{incl}}^2(F1C)$	$S_{SD_{incl}}^2(D1C)$	$S_{DD}^2(F1C)$	$S_{DD}^2(D1C)$
540	14.4%	13.1%	18.5%	17.5%	22.6%	22.0%
1800	10.9%	8.9%	14.5%	12.6%	18.2%	16.6%
14000	6.0%	5.2%	8.6%	8.1%	11.5%	11.2%

Applications

- Electroweak Vector boson processes
 - W^{+-} and Z^0 production
- Quarkonium hadroproduction at NLO
 - Application to Heavy-Ion Collisions
- Quarkonium production in NRQCD factorization
 - J/ψ + gamma
 - Upsilon + gamma
 - Nuclear production
- Higgs boson production
 - Diffractive factorization
 - Ultraperipheral Collisions

Electroweak vector boson production

W/Z Production

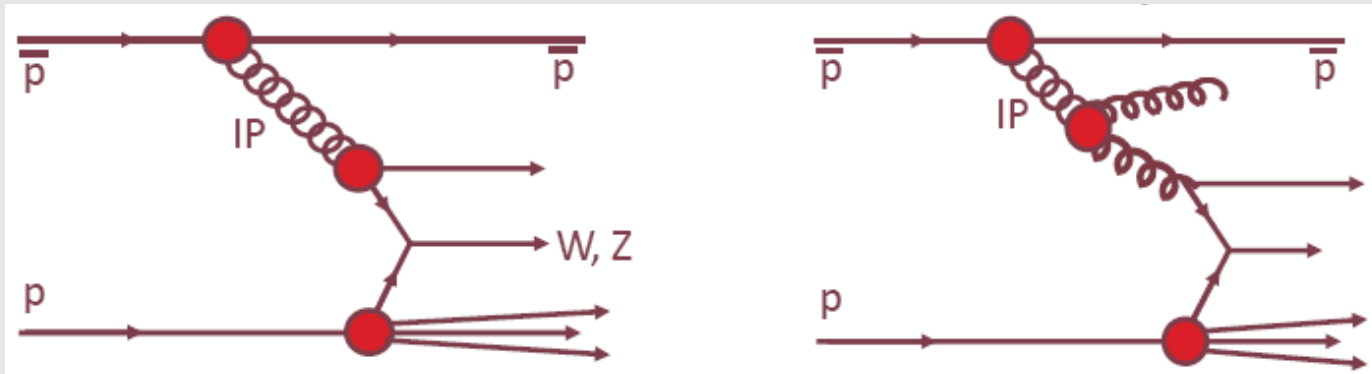

Leading order \longrightarrow W and Z produced by a quark in the Pomeron

- General cross section for W and Z

$$\frac{d\sigma}{dx_a dx_b} = \sum_{a,b} \int dx_a f_{a/p}(x_a, \mu^2) f_{b/\bar{p}}(x_b, \mu^2) \frac{d\hat{\sigma}(p\bar{p} \rightarrow [W/Z]X)}{d\hat{t}}$$

- W^+ (W^-) inclusive cross section

$$\frac{d\sigma}{d\eta_{e^-(e^+)}} = \sum_{a,b} \int dE_T f_{a/p}(x_a) f_{b/\bar{p}}(x_b) \left[\frac{V_{ab}^2 G_F^2}{6s\Gamma_W M_W} \right] \frac{\hat{t}^2 (\hat{u}^2)}{\sqrt{A^2 - 1}}$$

$$\mu^2 = M_W^2 \quad \hat{t} = -E_T M_W \left[A + \sqrt{A^2 - 1} \right]$$

$$G_F = 1.166 \times 10^{-5} \text{ GeV}^{-2}$$

- Total decay width $\longrightarrow \Gamma_W = 2.06 \text{ GeV}$

- V_{ab} is the CKM Matrix element

- W^+ (W^-) \longrightarrow dependence in t (u)

channel

W (Z) Diffractive cross sections

- $W^{+(-)}$ diffractive cross section

$$\frac{d\sigma}{d\eta_{e^-(e^+)}} = \sum_{a,b} \int dx_{IP} g(x_{IP}) \int dE_T f_{a/IP}(x_a) f_{b/\bar{p}}(x_b) \left[\frac{V_{ab}^2 G_F^2}{6s\Gamma_W M_W} \right] \frac{\hat{t}^2 (\hat{u}^2)}{\sqrt{A^2 - 1}}$$

- Z^0 diffractive cross section

$$\sigma = \sum_{a,b} \int \frac{dx_{IP}}{x_{IP}} \int \frac{dx_b}{x_b} \int \frac{dx_a}{x_a} \bar{f}(x_{IP}) f_{a/IP}(x_a, \mu^2) f_{b/\bar{p}}(x_b, \mu^2) \left[\frac{2\pi C_{ab}^Z G_F M_Z^2}{3\sqrt{2}s} \right] \frac{d\hat{\sigma}(ab \rightarrow ZX)}{d\hat{t}}$$

- $f_{a/IP}$ is the **quark distribution in the IP** \longrightarrow parametrization of the IP structure function (H1)
- $g(x_{IP})$ is the IP **flux integrated** over t

$$g(x_{IP}) = \int_{-\infty}^0 f_{IP/p}(x_{IP}, t) dt$$

$$C_{qq'}^Z = 1/2 - 2|e_q| \sin^2 \theta_W + 4|e_q|^2 \sin^4 \theta_W$$

- θ_W is the Weinberg or weak-mixing angle

Energies and Mandelstan Variables

- Total Energy $\longrightarrow E_e = \frac{\sqrt{s}}{4} [x_a(1 + \cos \theta) + x_b(1 - \cos \theta)]$
- Longitudinal Energy $\longrightarrow E_L = \frac{\sqrt{s}}{4} [x_a(1 + \cos \theta) - x_b(1 - \cos \theta)]$
- Transversal Energy $\longrightarrow E_T = \frac{M_W}{2} \sin \theta$
- Mandelstan variables of the process

$$\hat{t} = (p_c - p_a)^2 = -\frac{\hat{s}}{2} (1 - \cos \theta)$$

$$\hat{u} = (p_c - p_b)^2 = -\frac{\hat{s}}{2} (1 + \cos \theta)$$

$$\hat{s} = (p_a + p_b)^2 = M_W^2$$

$$\cos \theta = \pm \frac{\sqrt{A^2 - 1}}{A}$$

$$A = M_W / 2E_T$$

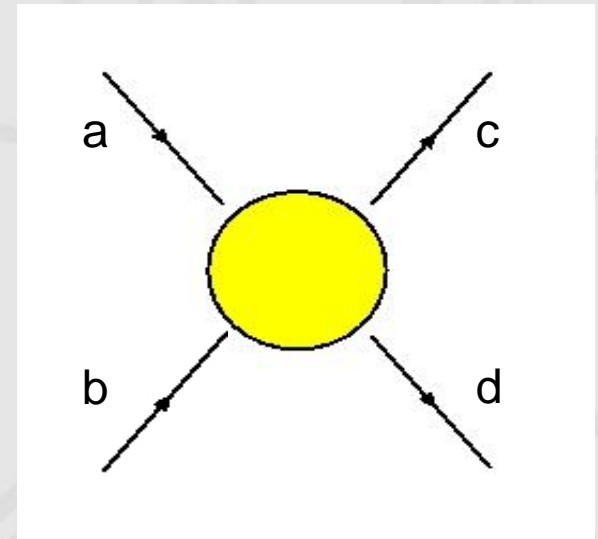

W⁺ and W⁻ Cross Sections

Tevatron [sqrt (s) = 1.8 TeV]

IS + GSP models

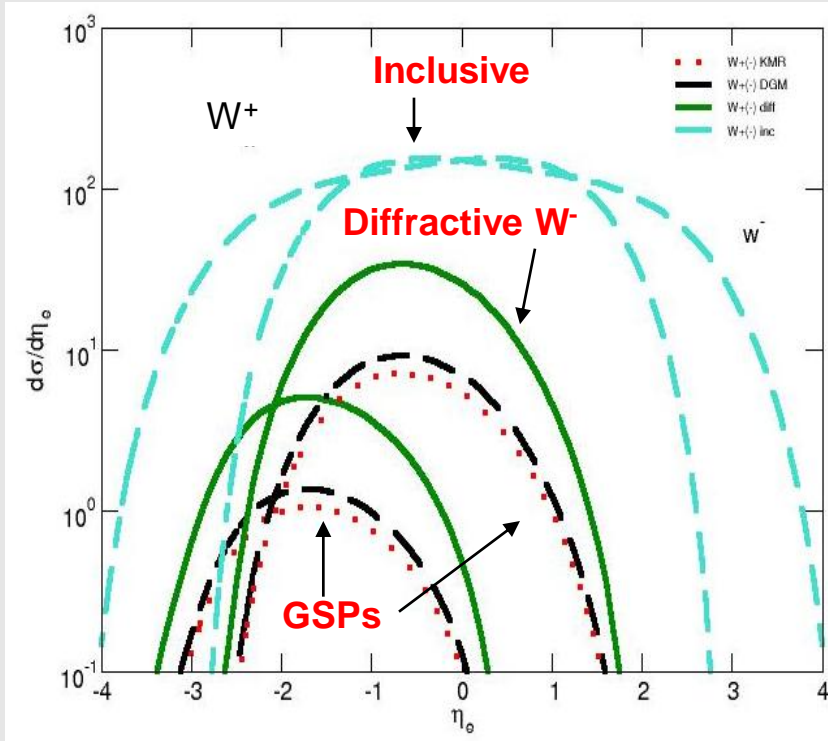

	Pseudo-rapidity	Data (%)	R(%)	
1.8 TeV	$ \eta_e < 1.1$	1.15 ± 0.55	0.715 ± 0.045	CDF
		1.08 ± 0.25	0.715 ± 0.045	
	$1.5 < \eta_e < 2.5$	0.64 ± 0.24	1.7 ± 0.875	D0
	Total $W \rightarrow e\nu$	0.89 ± 0.25	0.735 ± 0.055	
Total $Z \rightarrow e^+e^-$	1.44 ± 0.80	0.71 ± 0.05		

GSP is an average of KMR ($S^2 = 0.09$) and GLM ($S^2 = 0.086$) estimations

$$R = \frac{\int_{-\eta}^{\eta} \sigma_{diff}^{W^+} + \sigma_{diff}^{W^-}}{\int_{-\eta}^{\eta} \sigma_{inc}^{W^+} + \sigma_{inc}^{W^-}}$$

• Ranges

$$\left. \begin{array}{l} |\eta_e| < 1.1 \\ 1.5 < |\eta_e| < 2.5 \end{array} \right\}$$

- Tevatron, without GSP – 7.2 %

* $|\eta| < 1.1$

Quarkonium production in NRQCD

Diffractive hadroproduction

- o Focus on the following single diffractive processes

$$pp \rightarrow p + (J/\psi + \gamma) + X$$

$$pp \rightarrow p + (Y + \gamma) + X$$

- o Diffractive ratios as a function of transverse momentum p_T of quarkonium state

- o Quarkonia produced with large p_T  **easy to detect**

- o **Singlet contribution**

$$g + g \rightarrow \gamma + (c\bar{c})(^3S_1^{(1)})(\rightarrow J/\psi)$$

- o **Octet contributions**

$$g + g \rightarrow \gamma + (c\bar{c})(^1S_0^{(8)})(\rightarrow J/\psi),$$

$$g + g \rightarrow \gamma + (c\bar{c})(^3P_J^{(8)})(\rightarrow J/\psi),$$

- o Higher contribution on high p_T

NRQCD factorization

✓ $x_1(x_2)$ is the momentum fraction of the proton carried by the gluon

$M^2/s \leq x_1 < 1$ M \longrightarrow invariant mass of $J/\psi + \gamma$ system

$$x_2 = \frac{x_1 \bar{x}_T e^{-y} - 2\tau}{2x_1 - \bar{x}_T e^y}$$

$$\tau = \frac{m_\psi^2}{s}$$

✓ Cross section written as

$$\sigma(H) = \sum_n c_n \langle 0 | O_n^H | 0 \rangle$$

Coefficients are computable in perturbation theory

Matrix elements of NRQCD operators

Matrix elements

$$\langle 0 | O_n^H | 0 \rangle = \sum_X \sum_\lambda \langle 0 | \kappa_n^\dagger | H(\lambda) + X \rangle \langle H(\lambda) + X | \kappa_n | 0 \rangle$$

Bilinear in heavy quarks fields which create as a pair $Q\bar{Q}$ Quarkonium state

$$\begin{aligned} \frac{d\sigma}{dt}(g + g \rightarrow J/\psi + \gamma) = & \frac{\pi^2 e_c^2 \alpha \alpha_s^2 m_c}{s^2} \left[\frac{10}{9} \left(\frac{s^2 s_1^2 + t^2 t_1^2 + u^2 u_1^2}{s_1^2 t_1^2 u_1^2} \right) \langle O_8^{J/\psi}(^3S_1) \rangle \right. \\ & + \frac{16}{27} \left(\frac{s^2 s_1^2 + t^2 t_1^2 + u^2 u_1^2}{s_1^2 t_1^2 u_1^2} \right) \langle O_1^{J/\psi}(^3S_1) \rangle + \frac{3}{2} \frac{tu}{s s_1^2 m_c^2} \langle O_8^{J/\psi}(^3S_1) \rangle \\ & \left. + \frac{3}{2} \frac{1}{s s_1^2 m_c^4} \left(2s(2m_c)^2 + 3tu - \frac{4tu(2m_c)^2}{s_1} \right) \langle O_8^{J/\psi}(^1P_0) \rangle \right], \end{aligned}$$

$$s_1 = s - 4m_c^2, \quad t_1 = t - 4m_c^2, \quad u_1 = u - 4m_c^2$$

$$e_c = \frac{2}{3}$$

α_s running

Diffractive cross section

$$\frac{d^2\sigma_{SD}}{dydp_T} = \int_{x_{\mathbb{P}}^{min}}^{x_{\mathbb{P}}^{max}} dx_{\mathbb{P}} \int_{\frac{M^2}{sx_{\mathbb{P}}}}^1 dx_1 \int_{-1}^0 dt f_{\mathbb{P}/p}(x_{\mathbb{P}}, t)$$

$$\times g_{\mathbb{P}}(x_{\mathbb{P}}, \mu_F^2) g_p(x_2, \mu_F^2) \frac{4x_1 x_{\mathbb{P}} x_2 p_T}{2x_1 x_{\mathbb{P}} - \bar{x}_T e^y} \frac{d\hat{\sigma}}{d\hat{t}}$$

Momentum fraction carried by the Pomeron

Squared of the proton's four-momentum transfer

Pomeron flux factor

$$f_{\mathbb{P}/p}(x_{\mathbb{P}}, t) \propto x_{\mathbb{P}}^{1-2\alpha(t)} F^2(t)$$

$$\alpha(t) = \alpha_{\mathbb{P}}(0) + \alpha'_{\mathbb{P}} t \quad \text{Pomeron trajectory}$$

Results for $J/\psi + \gamma$

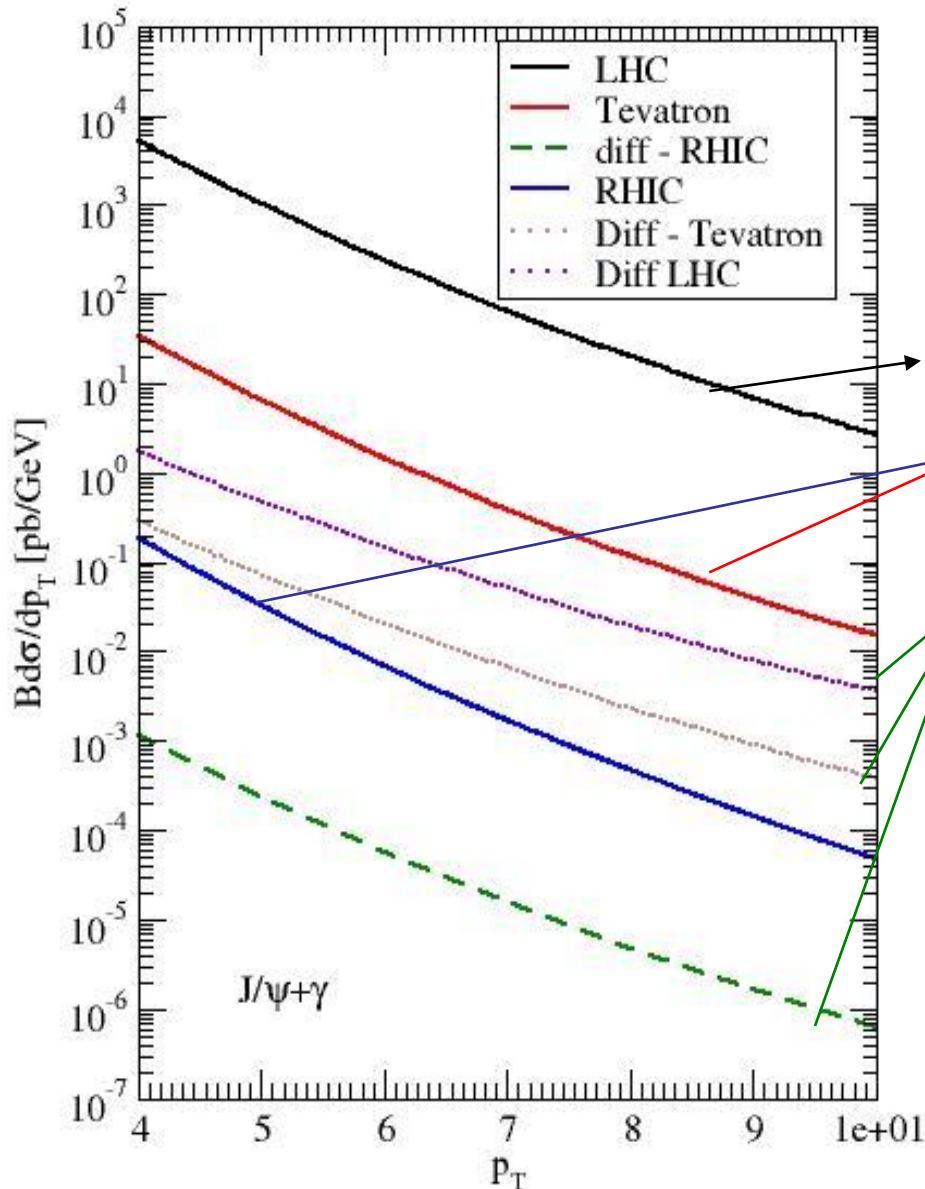

- Predictions for inclusive and diffractive cross sections

- LHC, Tevatron and RHIC

- Diffractive cross sections considering GSP ($\langle |S|^2 \rangle$)

- $B = 0.0594$ is the branching ratio into electrons

$$1 \leq p_T \leq 20 \text{ at LHC}$$

Results for $\Upsilon+\gamma$

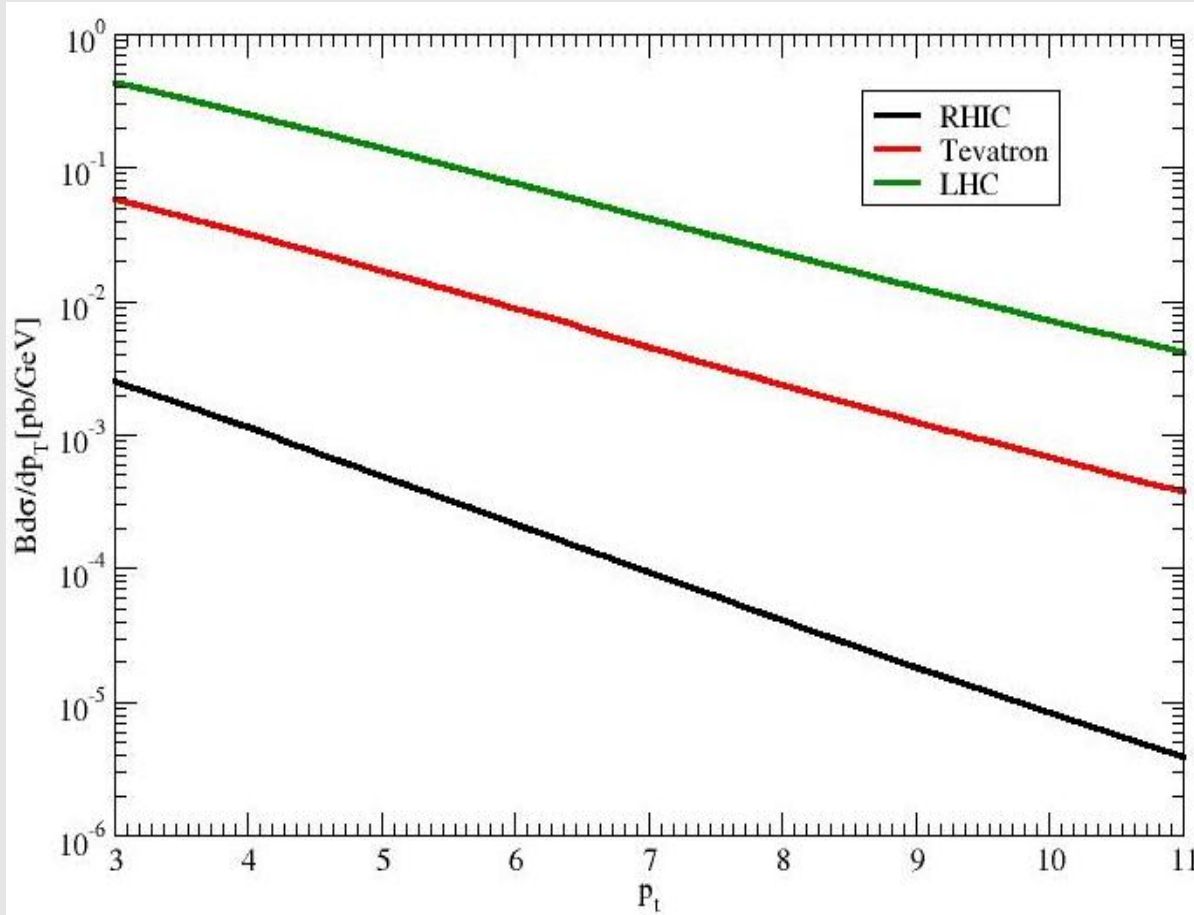

- Predictions of inclusive cross section
- **LHC**, **Tevatron** and RHC
- $-1 < |y| < 1$
- $B = 0.0238$ is the branching ratio into electrons

Results for $J/\psi+\gamma$ at LHC

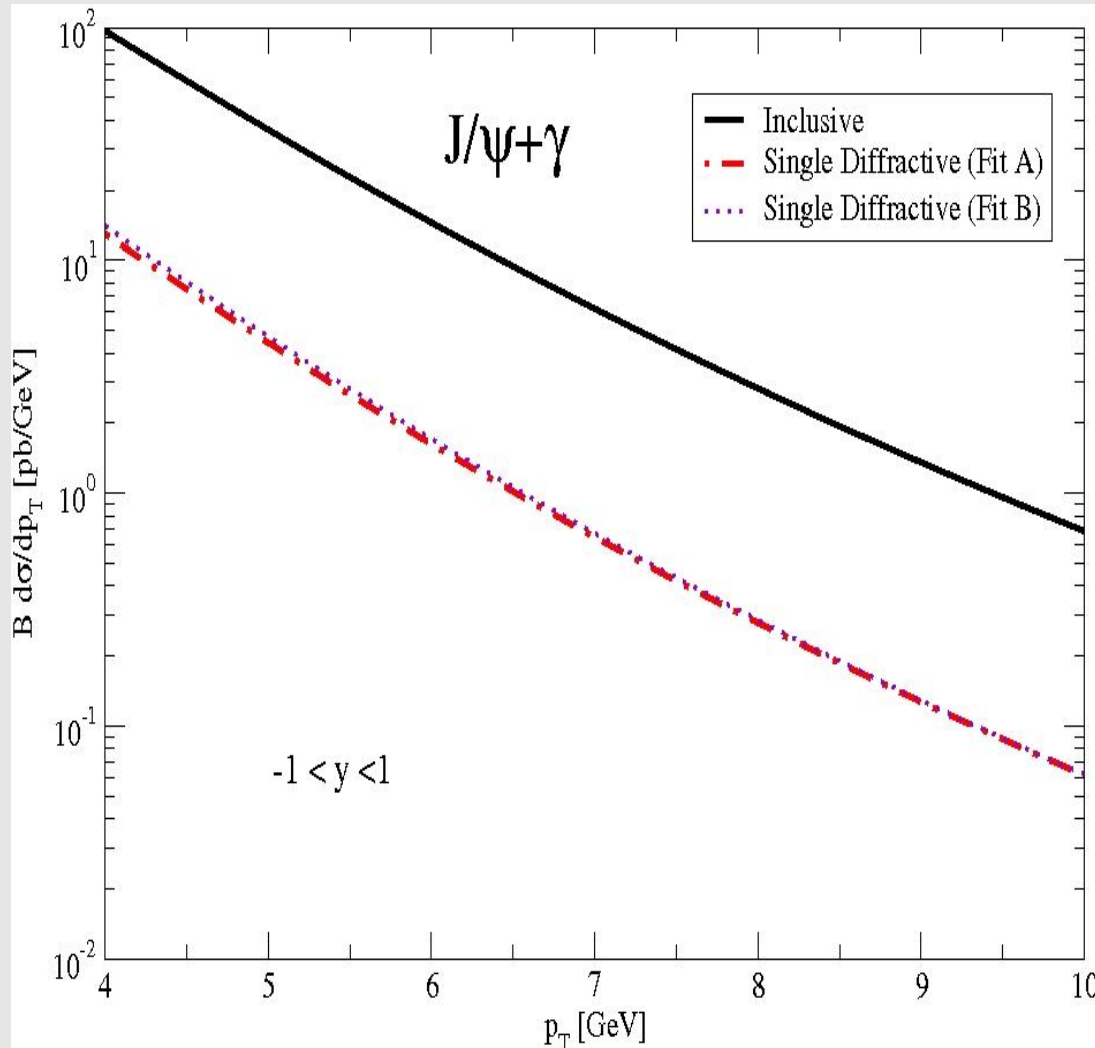

- $B = 0.0594$
- Absolute value cross section strongly dependent

Quark mass
NRQCD matrix elements
Factorization scale

- Diffractive cross sections (DCS) without GSP ($\langle |S|^2 \rangle$)
- Comparison between **two different sets** of diffractive gluon distribution (H1)

Results for $\Upsilon+\gamma$ at LHC

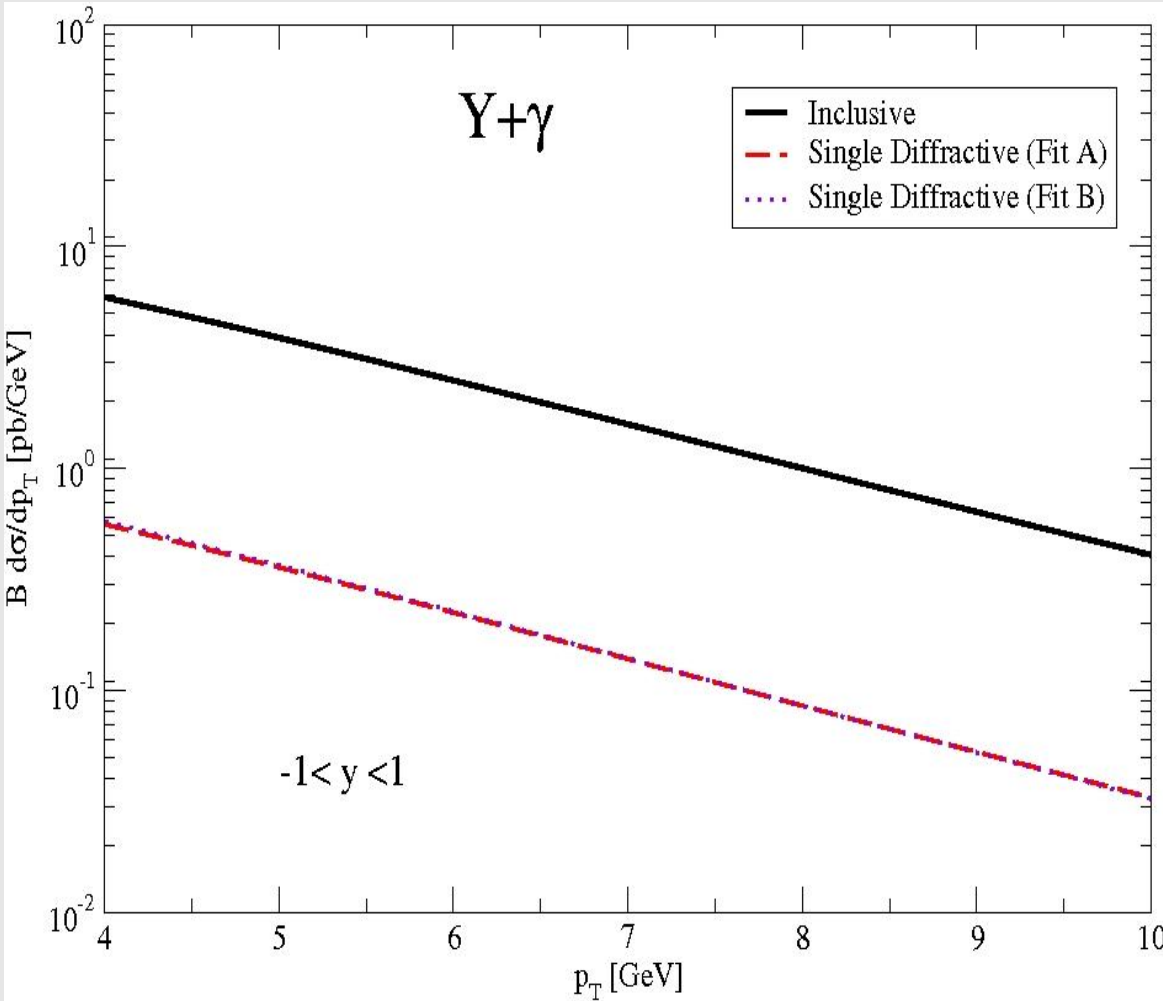

- $B = 0.0238$
- Absolute value cross section strongly dependent

Quark mass
NRQCD matrix elements
Factorization scale

- Diffractive cross sections (DCS) without GSP ($\langle |S|^2 \rangle$)
- Comparison between **two different sets** of diffractive gluon distribution (H1)

Diffractive ratio at LHC

p_T [GeV]	4	6	8	10
$\frac{d\sigma_{inc}}{dp_T} (J/\Psi)$	97.04	14.54	2.82	0.68
$\frac{d\sigma_{SD}}{dp_T} (J/\Psi)$	0.78	0.10	0.017	0.0036
$R_{SD} [\%] (J/\Psi)$	0.8	0.69	0.6	0.53
$\frac{d\sigma_{inc}}{dp_T} (\Upsilon)$	5.91	2.49	1.00	0.41
$\frac{d\sigma_{SD}}{dp_T} (\Upsilon)$	0.036	0.013	0.0054	0.0018
$R_{SD} [\%] (\Upsilon)$	0.6	0.53	0.54	0.44

** C. S. Kim, J. Lee and H. S. Song,
Phys Rev D59 (1999) 014028

$J/\psi + \gamma$

P_T (GeV)	4	5	6	7	8	9	10
$R (P_T)(\%)$	0.52	0.52	0.50	0.48	0.47	0.46	0.44

➤ Slightly large diffractive ratio in comparison to **

❖ Could explain the p_T dependence in our results

$[\sigma] = \text{pb}$
considering FIT A

This work	Ref **
$\mu_F = \sqrt{\frac{(p_T^2 + m_\psi^2)}{4}}$	$\mu_F = E_T$
$\langle S ^2 \rangle = 0.06$	Renormalized Pomeron flux
Q^2 evolution in the gluon density	No Q^2 evolution in the gluon density

Higgs production

MBGD, M. M. Machado, G. G. Silveira, PRD. 83, 074005 (2011)

Higgs production

- ✓ Standard Model (SM) of Particle Physics has unified the Electromagnetic interaction and the weak interaction;
- ✓ Particles acquire mass through their interaction with the Higgs Field;
- ✓ Existence of a new particle: the Higgs boson
- ✓ The theory does not predict the mass of H;
- ✓ Predicts its production rate and decay modes for each possible mass;

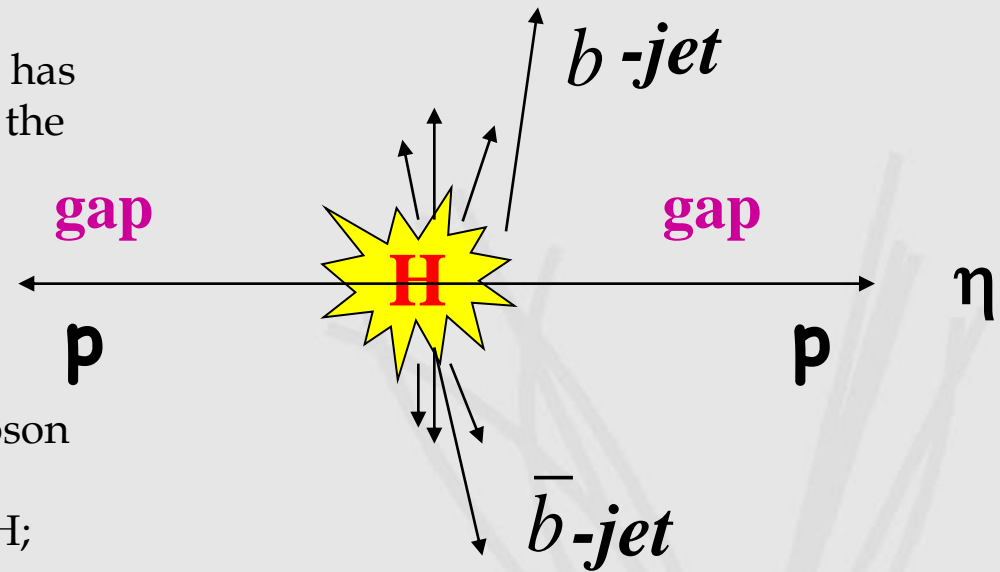

➤ Exclusive diffractive Higgs production $pp \rightarrow p H p$: 3-10 fb

➤ Inclusive diffractive Higgs production $pp \rightarrow p + X + H + Y + p$: 50-200 fb

Gluon fusion

o Focus on the gluon fusion

$$pp \rightarrow gg \rightarrow H$$

o Main production mechanism of **Higgs boson** in high-energy pp collisions

 Gluon coupling to the Higgs boson in SM

triangular loops of top quarks

Lowest order to gg contribution

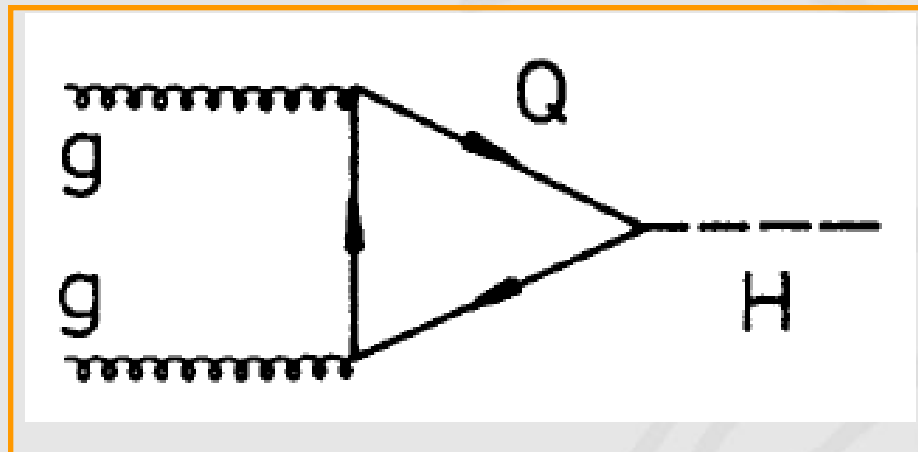

Gluon fusion

Lowest order

partonic cross section expressed by the gluonic width of the Higgs boson

$$\hat{\sigma}_{LO}(gg \rightarrow H) = \frac{\sigma_0}{m_H^2} \delta(\hat{s} - m_H^2)$$

$$\sigma_0 = \frac{8\pi^2}{m_H^3} \Gamma_{LO}(H \rightarrow gg)$$

$$\Gamma_{LO}(H \rightarrow gg) = \frac{G_F \alpha_s^2}{36 \sqrt{2} \pi^3} m_H^3 \left| \frac{3}{4} \sum_Q A_Q(\tau_Q) \right|^2$$

$$A_Q(\tau_Q) = 2[\tau + (\tau - 1)f(\tau)]/\tau^2$$

$$f(\tau) = \arcsin^2 \sqrt{\tau}$$

Quark Top

\hat{s}

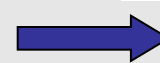

gg invariant energy squared

✓

dependence

τ_Q

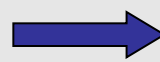

$$\tau_Q = m_H^2 / 4m_Q^2$$

LO hadroproduction

- ✓ Lowest order \longrightarrow two-gluon decay width of the Higgs boson

$$\sigma_0 = \frac{G_F \alpha_s^2(\mu^2)}{288 \sqrt{2} \pi} \left| \frac{3}{4} \sum_q A_Q(\tau_Q) \right|^2$$

- ✓ Gluon luminosity $\longrightarrow \frac{d\mathcal{L}^{gg}}{d\tau} = \int_{\tau}^1 \frac{dx}{x} g(x, M^2) g(\tau/x, M^2)$

PDFs
MSTW2008

- ✓ Lowest order proton-proton cross section

$$\sigma_{LO}(pp \rightarrow H) = \sigma_0 \tau_H \frac{d\mathcal{L}^{gg}}{d\tau_H}$$

- ✓ Renormalization scale μ_Q

$$\mathcal{T} \equiv \mathcal{T}_H$$

$$\tau_H = \frac{m_H^2}{s}$$

- ✓ s \longrightarrow invariant pp collider energy squared

Virtual diagrams

➤ Coefficient $C(\tau_Q)$ → contributions from the virtual two-loop corrections

➤ Regularized by the infrared singular part of the cross section for real gluon emission

$$C(\tau_Q) = \pi^2 + c(\tau_Q) + \frac{33 - 2N_F}{6} \ln \frac{\mu^2}{m_H^2}$$

✓ Infrared part

✓ Finite τ_Q dependent piece

✓ Logarithmic term depending on the renormalization scale μ

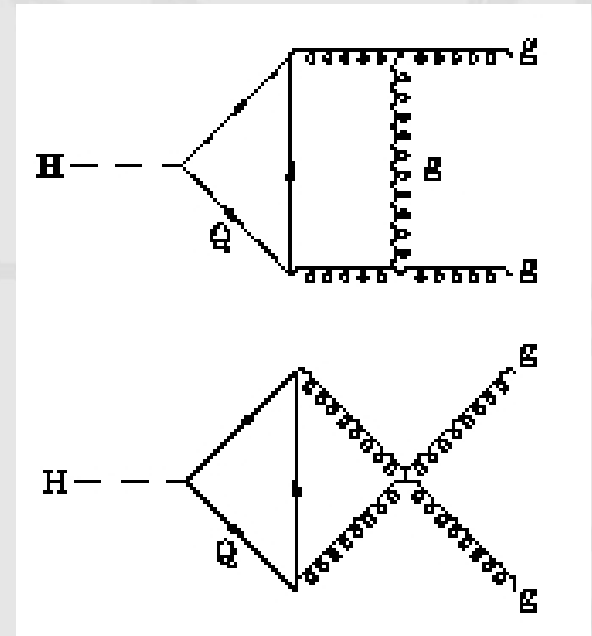

Delta functions

o Contributions from gluon radiation in gg , gq and qq scattering

o Dependence of the parton densities $\left\{ \begin{array}{l} \text{renormalization scale } \mu \\ \text{factorization scale } M \end{array} \right.$

$$\begin{aligned} \Delta\sigma_{gg} &= \int_{\tau_H}^1 d\tau \frac{d\mathcal{L}^{gg}}{d\tau} \times \frac{\alpha_s}{\pi} \sigma_0 \left\{ -\hat{\tau} P_{gg}(\hat{\tau}) \log \frac{M^2}{\hat{s}} + d_{gg}(\hat{\tau}, \tau_Q) \right. \\ &\quad \left. + 12 \left[\left(\frac{\log(1-\hat{\tau})}{1-\hat{\tau}} \right)_+ - \hat{\tau} [2 - \hat{\tau}(1-\hat{\tau})] \log(1-\hat{\tau}) \right] \right\} \\ \Delta\sigma_{gq} &= \int_{\tau_H}^1 d\tau \sum_{q,\bar{q}} \frac{d\mathcal{L}^{gq}}{d\tau} \times \frac{\alpha_s}{\pi} \sigma_0 \left\{ \hat{\tau} P_{gq}(\hat{\tau}) \left[-\frac{1}{2} \log \frac{M^2}{\hat{s}} + \log(1-\hat{\tau}) \right] + d_{gq}(\hat{\tau}, \tau_Q) \right\} \\ \Delta\sigma_{q\bar{q}} &= \int_{\tau_H}^1 d\tau \sum_q \frac{d\mathcal{L}^{q\bar{q}}}{d\tau} \times \frac{\alpha_s}{\pi} \sigma_0 d_{q\bar{q}}(\hat{\tau}, \tau_Q) \end{aligned} \quad \hat{\tau} = \tau_H / \tau$$

Renormalization scale

QCD coupling $\alpha_s(\mu^2)$ in the radiative corrections and LO cross sections

NLO Cross Section

❖ Gluon radiation \longrightarrow two parton final states

$$gg \rightarrow H$$

❖ Invariant energy $\hat{s} \geq m_H^2$ in the gg, gq and $q\bar{q}$ channels

❖ New scaling variable $\hat{\tau}$ \longrightarrow supplementing τ_H and τ_Q

$$\hat{\tau} = \frac{m_H^2}{\hat{s}}$$

❖ The final result for the pp cross section at NLO

$$\sigma(pp \rightarrow H + X) = \sigma_0 \left[1 + C \frac{\alpha_s}{\pi} \right] \tau_H \frac{d\mathcal{L}^{gg}}{d\tau_H} + \Delta\sigma_{gg} + \Delta\sigma_{gq} + \Delta\sigma_{q\bar{q}}$$

❖ Renormalization scale in α_s and the factorization scale of the parton densities to be fixed properly

Diffractive processes

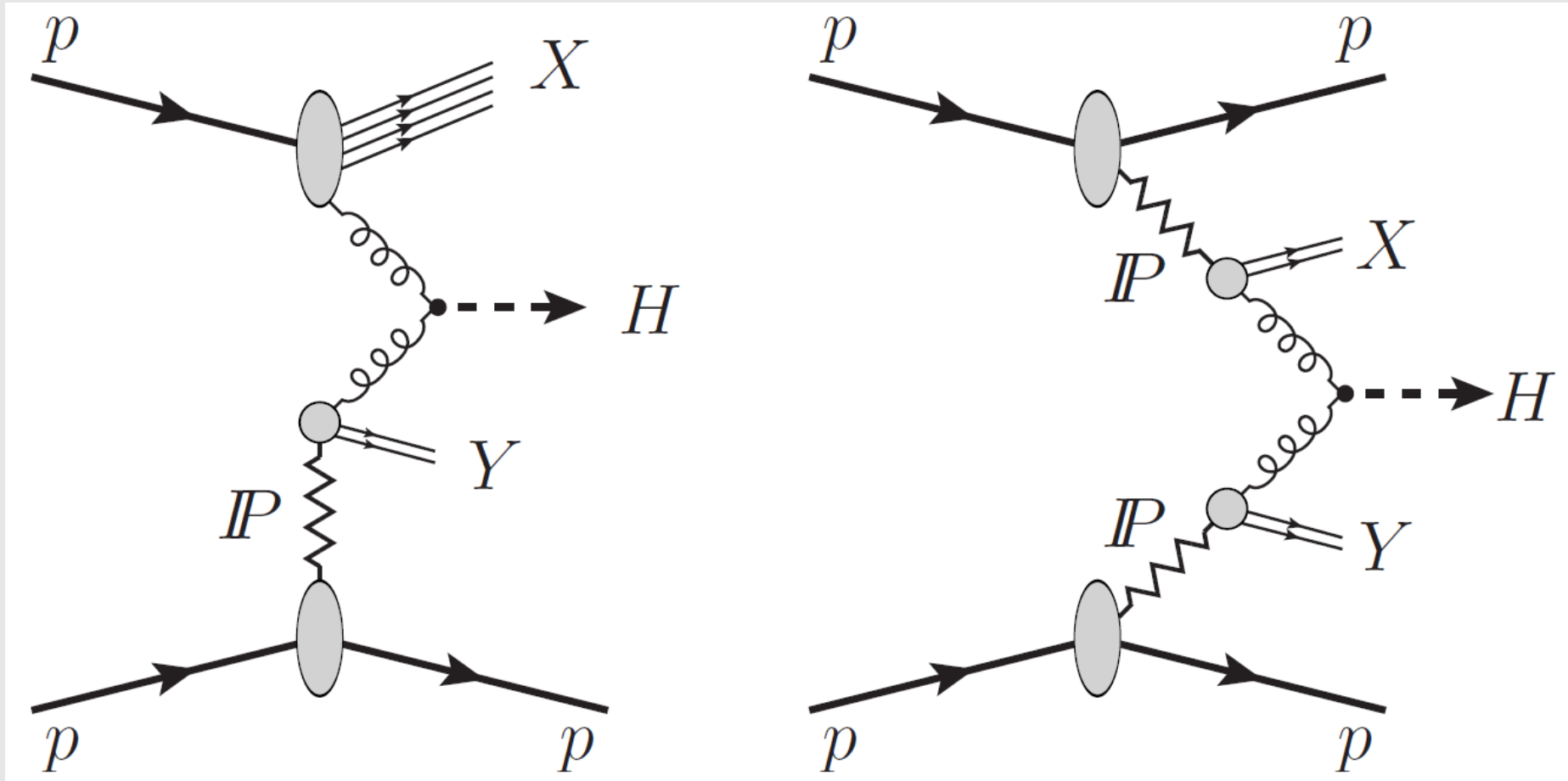

Single diffractive

Double Pomeron Exchange

Diffractive cross sections

Single diffractive

$$\sigma_{\mathbb{P}p \rightarrow H}(M_H, M_X) = C_g \int_0^1 \int_0^1 F_{g/p}(\xi_p) \cdot F_{g/\mathbb{P}}(\beta) \cdot \sigma_{gg \rightarrow H}(M_H, \hat{s}) d\beta d\xi_p$$

Double Pomeron Exchange

$$\sigma_{\mathbb{P}p \rightarrow H}(M_H, M_X) = C_g \int_0^1 \int_0^1 F_{g/\mathbb{P}_A}(\beta) F_{g/p_B}(\xi_p) \sigma_{gg \rightarrow H}(M_H, \hat{s}) d\beta d\xi_p$$

C_g

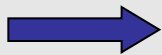

Normalization

Momentum fractions: pomeron and quarks

$$\xi = 1 - x_p$$

$$\beta = \frac{x}{x_{\mathbb{P}}}$$

$F_{g/p}(\xi_p)$

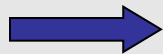

Gluon distributions in the proton **MSTW (2008)**

$F_{g/\mathbb{P}}(\beta)$

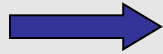

$$f_{\mathbb{P}/h}(x_{\mathbb{P}}) f_{i/\mathbb{P}}\left(\frac{x}{x_{\mathbb{P}}}, \mu^2\right)$$

H1 parametrization (2006)

Pomeron flux

Gluon distributions (i) in the Pomeron \mathbb{P}

FIT Comparison :: SD vs. DPE

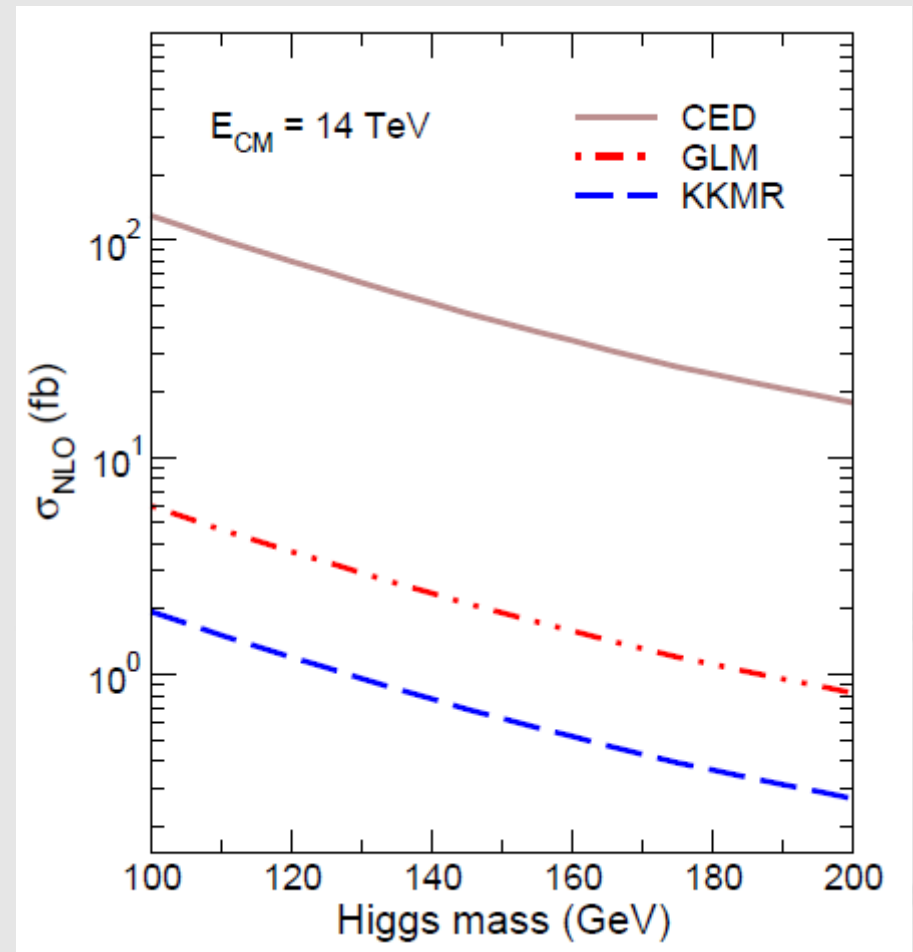
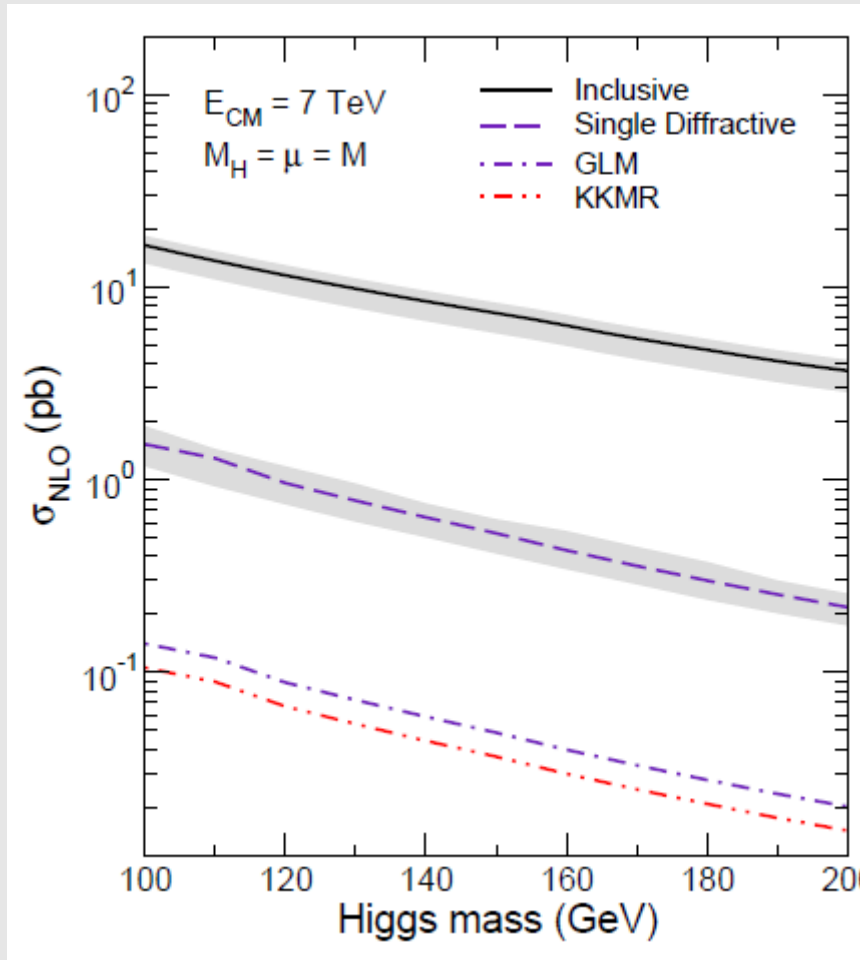

SD production as M_H function (NLO)

Mass (GeV)	\sqrt{s} (TeV)			
	1.96	7.	8.	14.
120	5.36(4.23)	88.59(66.44)	119.70(90.11)	346.43(256.62)
140	2.57(2.02)	58.69(44.02)	81.43(61.30)	248.75(184.26)
160	1.24(0.98)	39.56(29.67)	56.07(42.21)	183.06(135.60)
180	0.60(0.47)	27.60(20.70)	40.23(30.28)	134.46(99.60)
200	0.31(0.24)	19.96(14.97)	29.10(21.90)	104.65(77.52)

GLM

KKMR

Exclusive Higgs boson production

MBGD, G. G. Silveira, Phys. Rev. D 78, 113005 (2008)
MBGD, G. G. Silveira, Phys. Rev. D 82, 073004 (2011)

Diffractive Higgs Production

- The reaction $pp \rightarrow p + H + p$
- Protons lose small fraction of their energy :: **scattering in small angles**
- Nevertheless enough to produce the Higgs Boson

Durham
Model

$$\frac{d\sigma}{dy} = \frac{|M|^2}{16^2 \pi^3 b^2}$$

G_F is the Fermi constant and $Q_T^2 \equiv -\mathbf{Q}_T^2$

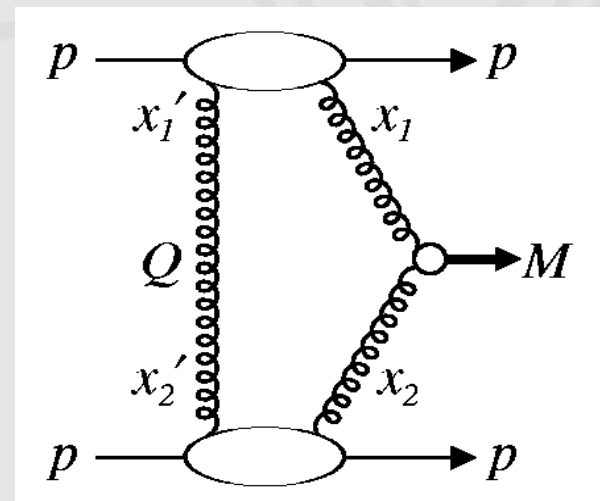

2-gluon emission

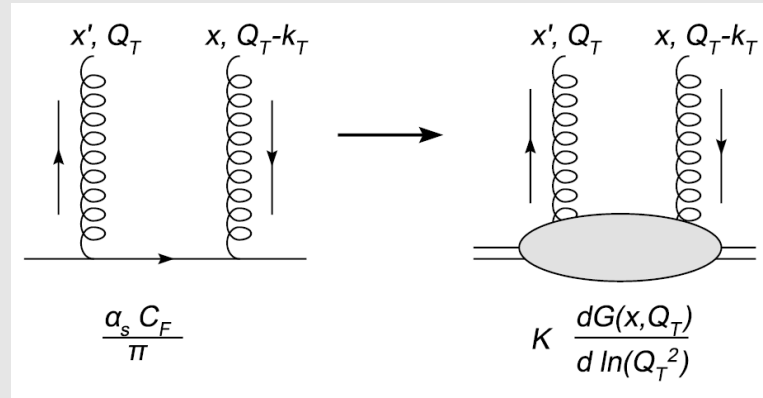

- The probability for a quark emit 2 gluon in the t-channel is given by the integrated gluon distribution

$$f(x, Q) \equiv K \partial G(x, Q) / \partial \ln Q^2$$

- The factor K is related to the non-diagonality of the distribution

$$K \approx e^{-bk_T^2/2} \frac{2^{2\lambda+3} \Gamma(\lambda + 5/2)}{\sqrt{\pi} \Gamma(\lambda + 4)}$$

$$\frac{d\sigma}{dy} \approx \frac{\alpha_s G_F \sqrt{2}}{9b^2} \left[\int \frac{d^2 Q_T}{Q_T^4} f(x_1, Q_T) f(x_2, Q_T) \right]^2$$

Sudakov form factors

- The former cross section is **infrared divergent!**
- The regulation of the amplitude can be done by suppression of gluon emissions from the production vertex;
- The Sudakov form factors accounts for the probability of emission of one gluon

$$\frac{C_A \alpha_s}{\pi} \int_{Q_T^2}^{m_H^2/4} \frac{dp_T^2}{p_T^2} \int_{p_T}^{m_H/2} \frac{dE}{E} \sim \frac{C_A \alpha_s}{4\pi} \ln^2 \left(\frac{m_H^2}{Q_T^2} \right)$$

- The **suppression** of several gluon emissions exponentiates

$$e^{-S} = \exp \left(- \int_{Q_T^2}^{m_H^2/4} \frac{dp_T^2}{p_T^2} \frac{\alpha_s(p_T^2)}{2\pi} \int_0^{1-\Delta} dz [z P_{gg}(z) + \sum_q P_{qg}(z)] \right)$$

- Then, the gluon distributions are modified in order to include S

$$\tilde{f}(x, Q_T) = \frac{\partial}{\partial \ln Q_T^2} \left(e^{-S/2} G(x, Q_T) \right)$$

Photoproduction mechanism

- The Durham group's approach is applied to the photon-proton process;
- This is a subprocess of **Ultrapерipheral Collisions**;
- Hard process: photon splitting into a color dipole, which interacts with the proton;

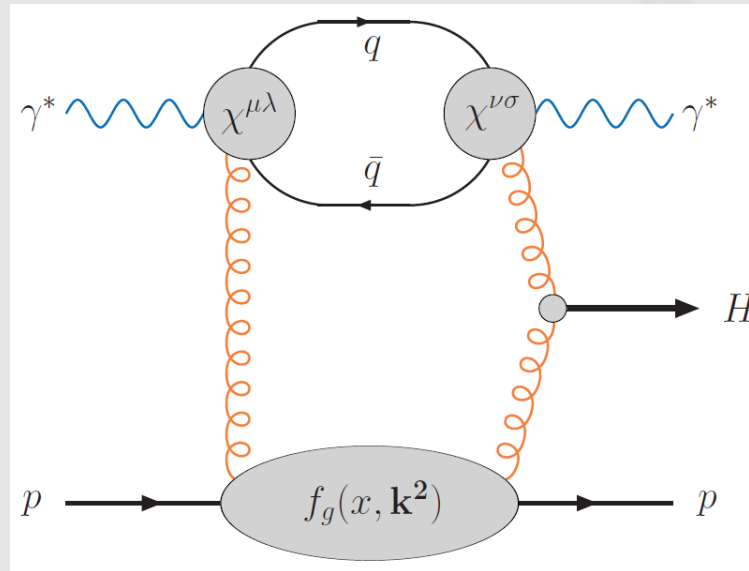

Dipole contribution

$$\Im A_T = -\frac{s}{3} \frac{M_H^2 \alpha_s^3 \alpha}{\pi v} \sum_q e_q^2 \left(\frac{2C_F}{N_c} \right) \int \frac{d\mathbf{k}^2}{k^6} \int_0^1 \frac{[\tau^2 + (1-\tau)^2][\alpha_\ell^2 + (1-\alpha_\ell)^2] k^2}{k^2 \tau(1-\tau) + Q^2 \alpha_\ell(1-\alpha_\ell)} d\alpha_\ell d\tau.$$

γp cross section

- ▶ The cross section is calculated for central rapidity ($y_H = 0$)

$$\left. \frac{d\sigma}{dy_H dt} \right|_{y_H, t=0} = \frac{S_{gap}^2}{2\pi B} \left(\frac{\alpha_s^2 \alpha M_H^2}{3N_c \pi v} \right)^2 \left(\sum_q e_q^2 \right)^2 \left[\int_{k_0^2}^{\infty} \frac{dk^2}{k^6} e^{-S(k^2, M_H^2)} f_g(x, \mathbf{k}^2) \mathcal{X}(\mathbf{k}^2, Q^2) \right]^2$$

- ▶ Proton content¹: $\alpha_s C_F / \pi \rightarrow f_g(x, \mathbf{k}^2) = \mathcal{K} \partial_{(\ln k^2)} xg(x, \mathbf{k}^2)$
- ▶ Gap Survival Probability²: $S_{gap}^2 \rightarrow 3\%$ (5%) for LHC (Tevatron)
- ▶ Gluon radiation suppression³: Sudakov factor $S(\mathbf{k}^2, M_H^2) \sim \ln^2(M_H^2/4\mathbf{k}^2)$
- ▶ Cutoff k_0^2 : Necessary to avoid infrared divergencies :: $k_0^2 = 1 \text{ GeV}^2$.
- ▶ Electroweak vacuum expectation value: $v = 246 \text{ GeV}$
- ▶ Gluon-proton form factor: $B = 5.5 \text{ GeV}^{-2}$

¹ Khoze, Martin, Ryskin, EJPC **14** (2000) 525

² Khoze, Martin, Ryskin, EJPC **18** (2000) 167

³ Forshaw, hep-ph/0508274

Ultraperipheral Collisions

- Photon emission from the proton

$$\sigma(pp(A) \rightarrow p + H + p(A)) = 2 \int_{\omega_0}^{\sqrt{s}/2} d\omega \frac{dn_i}{d\omega} \sigma_{\gamma p}(\omega, M_H),$$

with photon fluxes

$$\frac{dn_p}{d\omega} = \frac{\alpha_{em}}{2\pi\omega} \left[1 + \left(1 - \frac{2\omega}{\sqrt{s}} \right)^2 \right] \left(\ln A - \frac{11}{6} + \frac{3}{A} - \frac{3}{2A^2} + \frac{1}{3A^2} \right).$$

$$\frac{dn_A}{d\omega} = \frac{2Z^2 \alpha_{em}}{\pi\omega} \left[\mu K_0(\mu) K_1(\mu) - \frac{\mu^2}{2} [K_1^2(\mu) - K_0^2(\mu)] \right].$$

- The photon virtuality obey the **Coherent condition** for its emission from a hadron under collision

$$Q^2 \lesssim 1/R^2$$

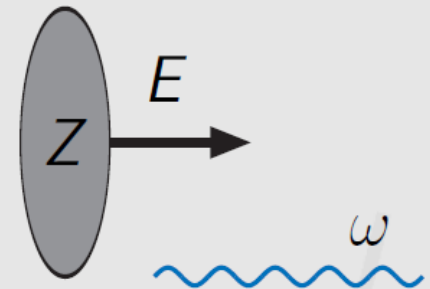
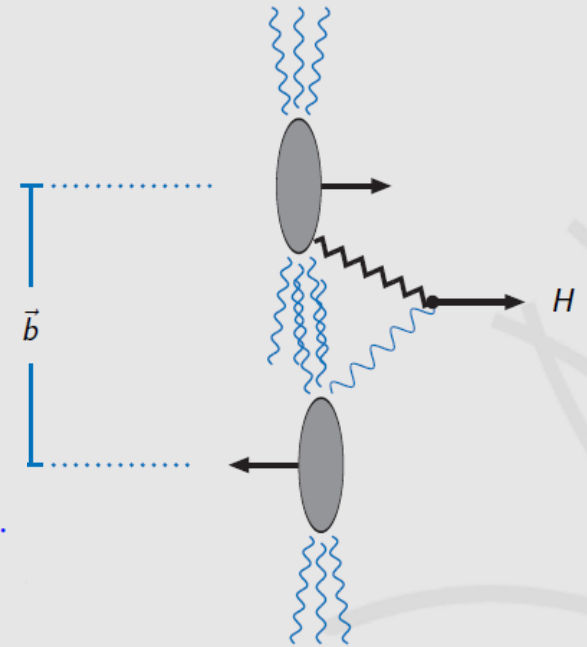

Photoproduction cross section

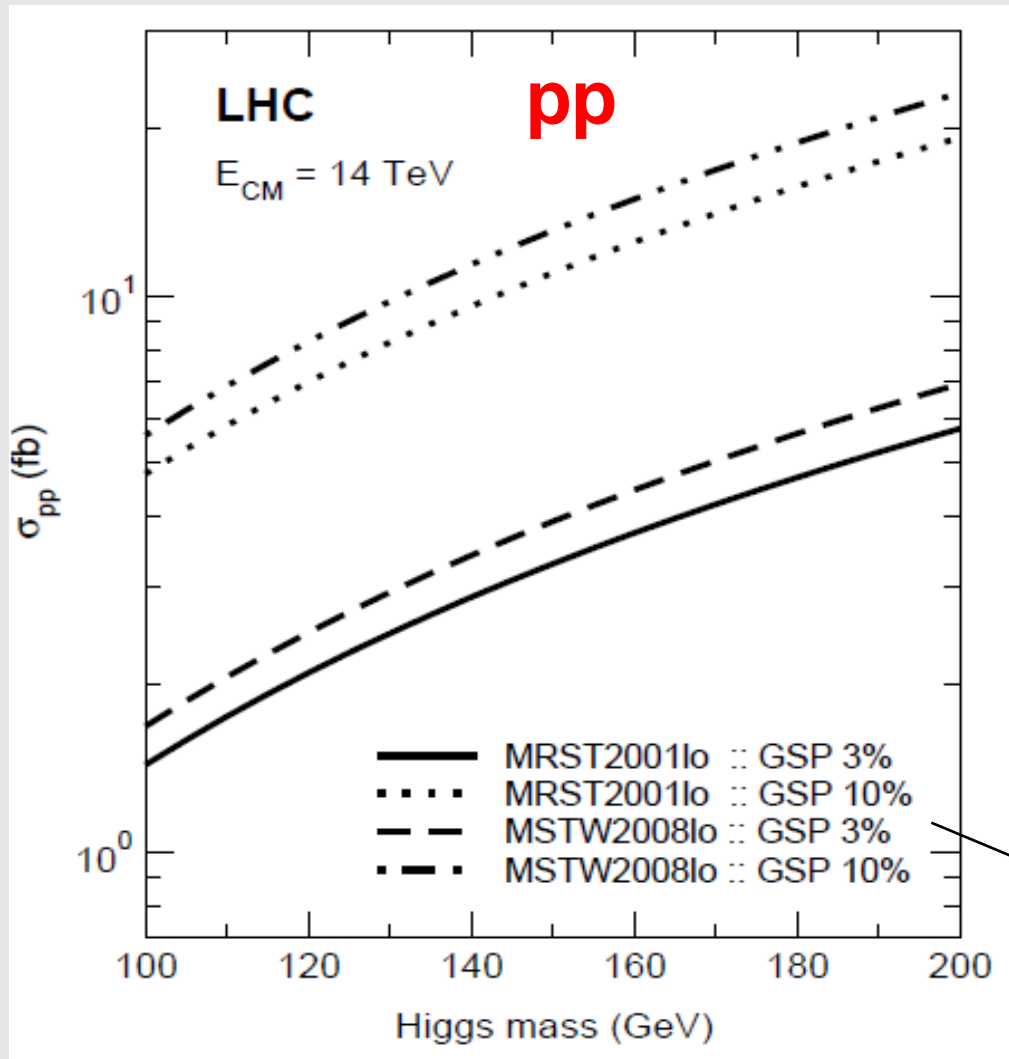

Subprocess	GSP (%)	σ_{pp} (fb)
IP	2.6	3.00
IP	0.4	0.47
$\gamma\gamma$	100	0.12
γp	3.0	1.77
γp	10.	5.92

$M_H = 120 \text{ GeV}$
Cross section = 1.77-6 fb

Estimations for the GSP in the LHC energy

pA collisions

Process	σ (fb)	BR \times σ (fb)	\mathcal{L} (fb $^{-1}$)	Events/yr
<i>pp</i>	1.77	1.27	1.(30.)	1 (30)
<i>pp</i>	5.92	4.26	1.(30.)	6 (180)
<i>pPb</i>	617.	444.	0.035	21
<i>pPb</i>	2056.	1480.	0.035	72

BR(H \rightarrow bb-bar) = 72%

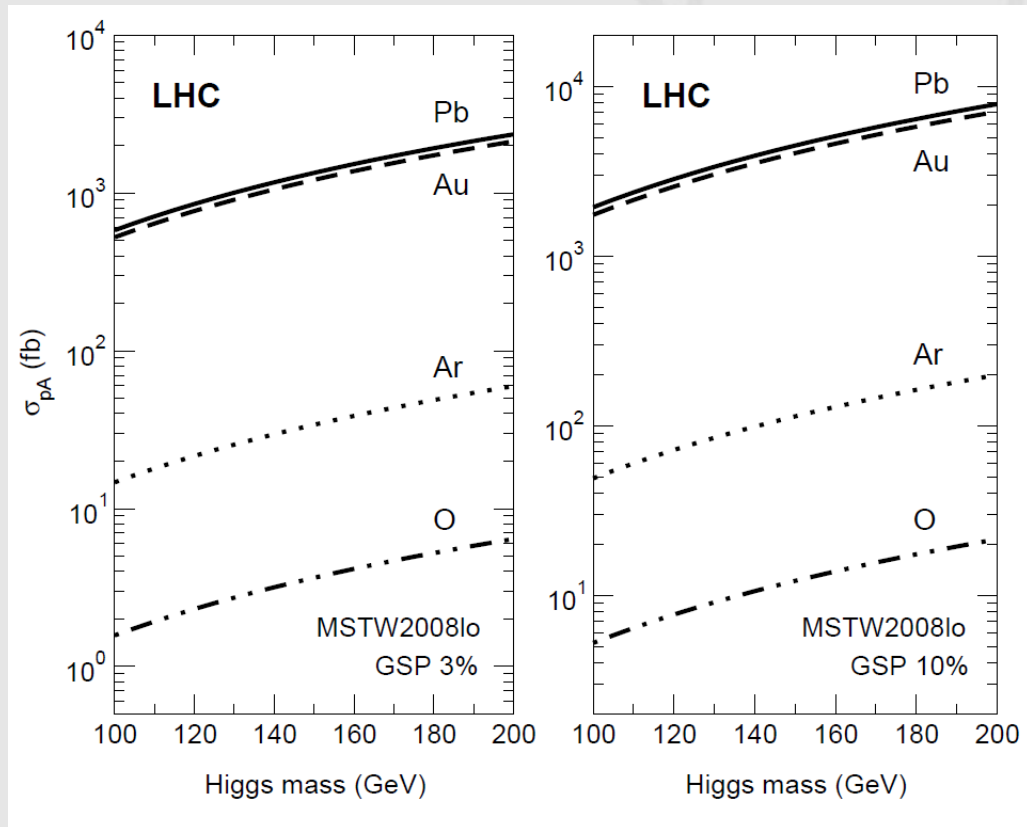

Summary results

✓ Diffraction with absorptive corrections (gap survival probability)

→ describe Tevatron data for W^{+-} and Z^0 production

→ rate production for **quarkonium + photon** at LHC energies

$$R^{(J/\psi)}_{SD} = 0,8 - 0,5 \% \quad R^{(\Upsilon)}_{SD} = 0,6 - 0,4 \% (\text{first in literature})$$

→ predictions for **heavy quark production** (SD and DPE) at LHC energies possible to be verified in AA collision

(diffractive cross section in **pp**, **pA** and **AA** collisions)

$$C\bar{C} \quad B\bar{B}$$

A = Lead and Calcium

→ Higgs predictions in agreement with Hard Pomeron Exchange

Cross sections of Higgs production 1 fb (**DPE**); 60-80 fb (**SD**)

Summary results

✓ Exclusive photoproduction is promising for the LHC

- strong **suppression** of backgrounds
 - cross section prediction → **2-6 fb**
 - expecting between **1** and **6** events **per year**
 - **additional signature** with the H associated production
 - **High event rates** for pA collisions
- $\sigma = 1 \text{ pb}$ → pPb collisions

Where we are

IP approach \Rightarrow **successes and failures**

Perturbative + non-perturbative QCD \Rightarrow **How exactly** contribute?

- ✓ Diffraction at HERA (Soft diffraction) described by factorization model (IS)
- ✓ Same model doesn't describe Tevatron data (Hard diffraction)
- ✓ Solution? \Rightarrow **Factorization + Gap Survival Probability** is a possibility,

BUT NOT THE ONLY ONE

- ✓ Breaking of factorization?

NEXT \Rightarrow Overall theoretical understanding

\Rightarrow LHC \rightarrow Diffractive Higgs production?

\rightarrow Diffraction at nuclei collisions?

\rightarrow Diffractive production of X_c, X_b, \dots ?

Next

DIFFRACTION IN NUCLEAR COLLISIONS

- ✓ Gap survival probability for nuclear collisions
- ✓ Dijets in hadronic and nuclear collisions
- ✓ ...

BACKUP

Predictions (LHC – 14 TeV)

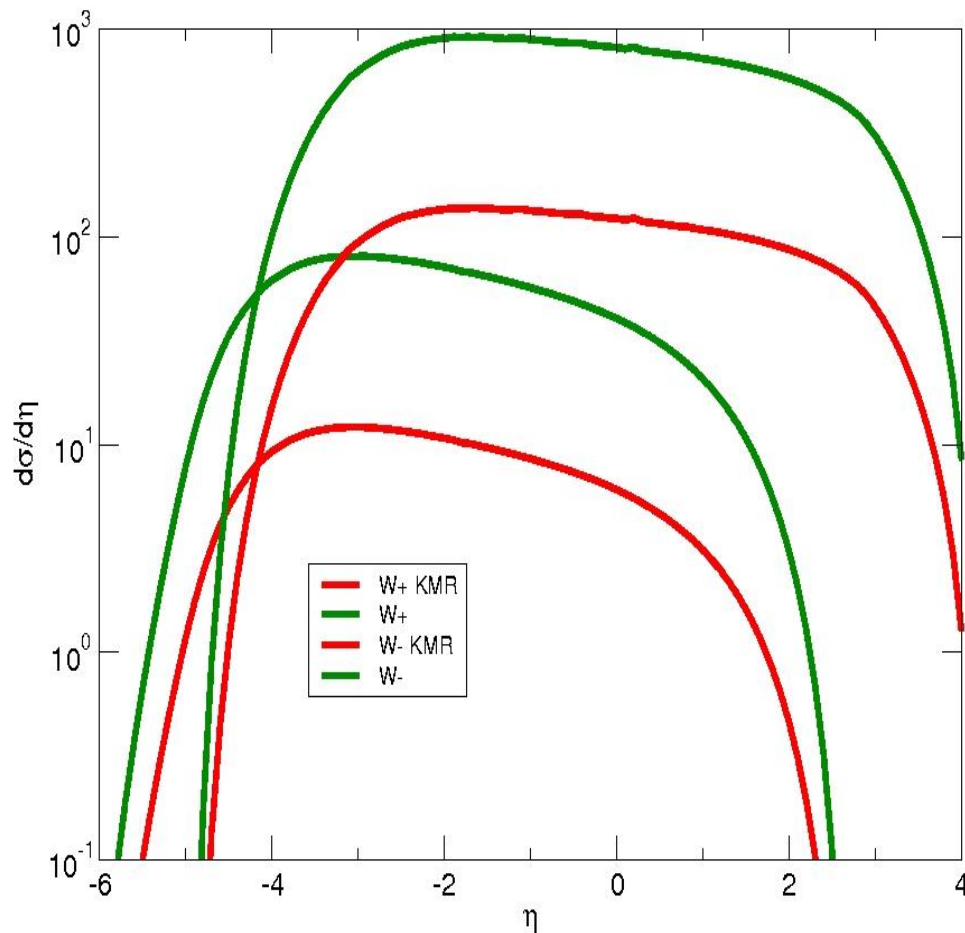

High diffractive ratio

$$R_{KMR} = \frac{\int_{-1}^1 \sigma_{diffactive}}{\int_{-1}^1 \sigma_{inclusive}} = 0.311$$

Large range of pseudorapidity

$$-6 \leq \eta \leq 6$$

Bialas-Landshoff approach

Double Pomeron Exchange

$$p + p \rightarrow p + Q\bar{Q} + p$$

$$\sigma_{\text{IP}}(\text{BL}) = \frac{1}{2s (2\pi)^8} \int \overline{|M_{fi}|^2} [F(t_1) F(t_2)]^2 dPH.$$

$F(t)$  nucleon form-factor

$$F(t) = \exp(bt)$$

$$b = 2 \text{ GeV}^{-2}$$

Differential phase-space factor

$$\begin{aligned} dPH &= d^4 k_1 \delta(k_1^2) d^4 k_2 \delta(k_2^2) d^4 r_1 \delta(r_1^2 - m_Q^2) \\ &\times d^4 r_2 \delta(r_2^2 - m_Q^2) \Theta(k_1^0) \Theta(k_2^0) \Theta(r_1^0) \Theta(r_2^0) \\ &\times \delta^{(4)}(p_1 + p_2 - k_1 - k_2 - r_1 - r_2), \end{aligned}$$

m_Q  mass of produced quarks

Bialas-Landshoff approach

Sudakov parametrization for momenta

$$Q = \frac{x}{s}p_1 + \frac{y}{s}p_2 + v, \quad k_1 = x_1p_1 + \frac{y_1}{s}p_2 + v_1,$$
$$k_2 = \frac{x_2}{s}p_1 + y_2p_2 + v_2, \quad r_2 = x_Qp_1 + y_Qp_2 + v_Q,$$

v, v_1, v_2, v_Q

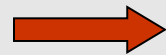

two-dimensional four-vectors describing the transverse component of the momenta

p_1, p_2 (k_1, k_2)



momenta for the incoming (outgoing) protons

r_2 (r_1)



momentum for the produced quark (antiquark)

Q



momentum for one of exchanged gluons

Bialas-Landshoff approach

Square of the invariant matrix element averaged over initial spins and summed over final spins

$$\overline{|M_{fi}|^2} = \frac{x_1 y_2 H}{(s x_Q y_Q)^2 (\delta_1 \delta_2)^{1+2\epsilon} \delta_1^{2\alpha' t_1} \delta_2^{2\alpha' t_2}} \left(1 - \frac{4 m_Q^2}{s \delta_1 \delta_2} \right) \exp [2\beta (t_1 + t_2)]$$

$$\delta_1 = 1 - x_1, \delta_2 = 1 - y_2, t_1 = -\vec{v}_1^2, t_2 = -\vec{v}_2^2, \beta = 1 \text{ GeV}^{-2}$$

$\exp [2\beta (t_1 + t_2)]$  effect of the momentum transfer dependence of the non-perturbative gluon propagator

$$H = S_{\text{gap}}^2 \times 2s \left[\frac{4\pi m_Q (G^2 D_0)^3 \mu^4}{9 (2\pi)^2} \right]^2 \left(\frac{\alpha_s}{\alpha_0} \right)^2$$

$$\epsilon = 0.08, \alpha' = 0.25 \text{ GeV}^{-2}, \mu = 1.1 \text{ GeV}$$

$$G^2 D_0 = 30 \text{ GeV}^{-1} \mu^{-1}$$

Partonic Structure of the Pomeron

✓ Diffractive **quark distributions** and **quark distributions of the Pomeron** are related

$$\frac{df_q(\beta, Q^2, x_{IP}, t)}{dx_{IP} dt} = \frac{1}{16\pi^2} |g_{IP}(t)|^2 x_{IP}^{-2\alpha_{IP}(t)} q^{IP}(\beta, Q^2)$$

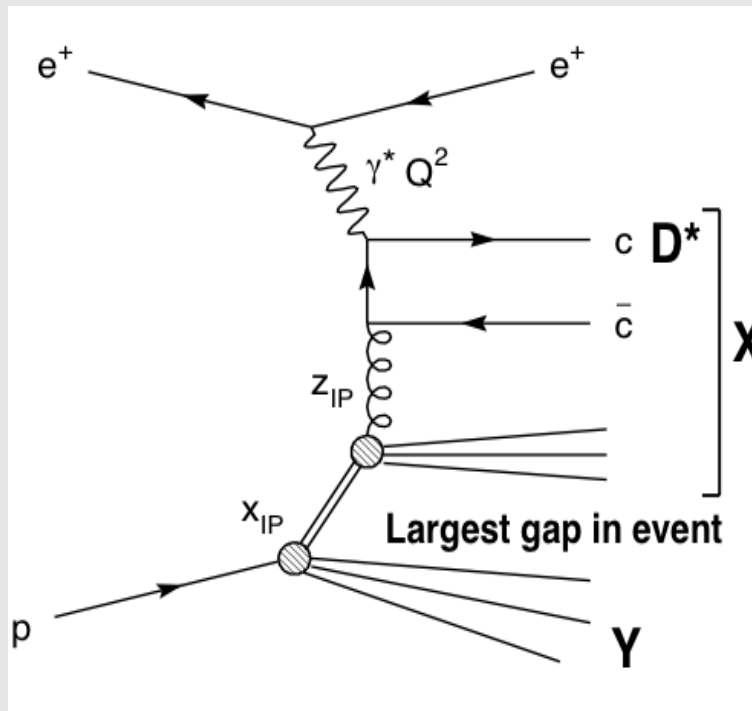

- Introducing gluon distribution in the Pomeron

$$g^{IP}(\beta, Q^2)$$

- Related to $df_g / dx_{IP} dt$ by

$$\frac{df_g(\beta, Q^2, x_{IP}, t)}{dx_{IP} dt} = \frac{1}{16\pi^2} |g_{IP}(t)|^2 x_{IP}^{-2\alpha_{IP}(t)} g^{IP}(\beta, Q^2)$$

- At Next-to-Leading order, **Pomeron Structure Function** acquires a term containing $g^{IP}(\beta, Q^2)$

Representation of D^* diffractive production in the infinite-momentum frame description of DDIS

Diffraction processes

- Hadronic processes can be characterized by an **energy scale**

➡ Soft processes - energy scale of the order of the **hadron size** (~ 1 fm)
pQCD is **inadequate** to describe these processes

$$\alpha_{soft}(t) = 1.08 + 0.25t$$

➡ Hard processes - “hard” energy scale (> 1 GeV²)

can **use pQCD**

“factorization theorems”

Separation of the **perturbative** part from **non-perturbative**

$$\alpha_{hard}(t) = 1.30 + 0.02t$$

- Most of diffractive processes at HERA ➡ **“soft processes”**

Pomeron as composite

- Considering Regge factorization we have

$$F_2^{D(4)}(x, Q^2, x_{IP}, t) = f_{IP/p}(x_{IP}, t) F_2^{IP}(\beta, Q^2)$$

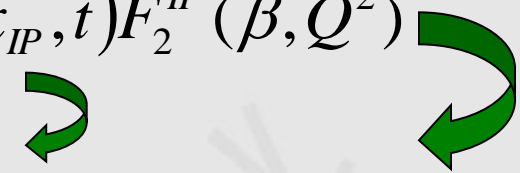

see MBGD & M. V. T. Machado 2001

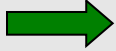
Data  Good fit with added Reggeon for HERA

Pomeron as gluons

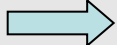
- Elastic amplitude  neutral exchange in t-channel
- Smallness of the real part of the diffractive amplitude  nonabeliance

Born graphs in the abelian and nonabelian (QCD) cases look like

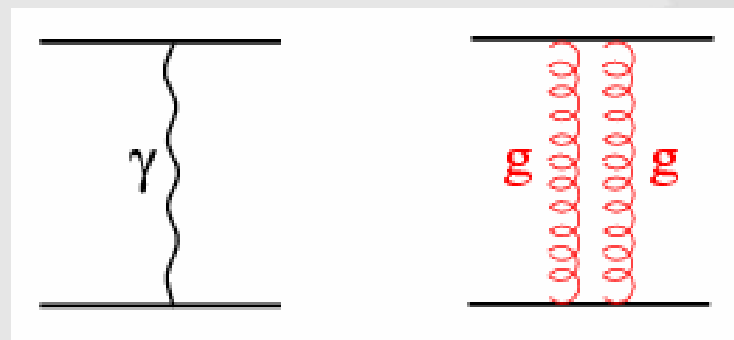

The Pomeron

- o From fitting elastic scattering data *IP* trajectory is much flatter than others
- o For the intercept $\alpha'_{IP} \approx 0.25 \text{ GeV}^{-2}$ total cross sections implies $\alpha_{IP}(0) \approx 1$
- o Pomeron \longrightarrow dominant trajectory in the elastic and diffractive processes
- o Known to proceed via the exchange of **vacuum quantum numbers** in the *t*-channel

Regge-type $\alpha(t) = \alpha(0) + \alpha' t$

First measurements in h-h scattering

$$W^2 = (q + p)^2$$

$$\frac{d\sigma}{dt}(W) = \exp(b_0 t) W^{2[2\alpha_{IP}(t)+2]}$$

✓ $\alpha(0)$ and α' are **fundamental parameters** to represent the basic features of strong interactions

$$\frac{d\sigma}{dt}(W) = W^{4\alpha(0)-4} \exp(bt)$$

$$b = b_0 + 4\alpha' \ln(W)$$

✓ α' \longrightarrow energy dependence of the transverse system

Pomeron structure function

- Pomeron structure function has been modeled in terms of a light flavor singlet distribution $\Sigma(z)$
- Consists of u, d and s quarks and antiquarks and a gluon distribution $g(z)$
- z is the longitudinal momentum fraction of the parton entering the hard subprocess with respect of the diffractive exchange
- ($z = \beta$) for the lowest order quark-parton model process and $0 < \beta < z$ for higher order processes
- Quark singlet and gluon distributions are parametrized at Q_0^2

$$zf_{i/IP}(z, Q_0^2) = A_i z^{B_i} (1-z)^{C_i} \exp\left[-\frac{0.01}{(1-z)}\right]$$

Pomeron structure function

<i>Parameter</i>	<i>Value</i>
α'_{IP}	$0.06^{+0.19}_{-0.06} GeV^{-2}$
B_{IP}	$5.5^{+2.0}_{-0.7} GeV^{-2}$
$\alpha_{IR}(0)$	0.50 ± 0.10
α'_{IR}	$0.3^{+0.6}_{-0.3} GeV^{-2}$
B_{IR}	$1.6^{+1.6}_{-0.4} GeV^{-2}$
m_c	$1.4 \pm 0.2 GeV$
m_b	$4.5 \pm 0.5 GeV$
$\alpha_8^{(5)} (M_Z^2)$	0.118 ± 0.002

- Values of fixed parameters (masses) and their uncertainties, as used in the QCD fits.
- α'_{IP} and B_{IP} (strongly anti-correlated) are varied simultaneously to obtain the theoretical errors on the fits (as well as α'_{IR} and B_{IR}).
- Remaining parameters are varied independently.
- Theoretical uncertainties on the free parameters of the fit are sensitive to the variation of the parametrization scale Q_0^2

The HERA Collider

Publications on diffraction made by H1 Collaboration *



Event	Number of papers
Diffractive Cross Sections (SD, DD)	11
Diffractive Final States	14
Quasi-elastic Cross Sections	20
Total cross sections / decomposition	2

Similar numbers to ZEUS Collaboration



The Tevatron Collider

Publications on diffraction made by CDF Collaboration

Soft Diffraction

Mesropian, Summerschool Acquafredda (2010)

Single Diffraction - PRD 50, 5355 (1994)

Double Diffraction - PRL 87, 141802 (2001)

Double Pomeron Exchange - PRL 93, 141603 (2004)

Multi-gap Diffraction - PRL 91, 011802 (2003)

Hard Diffraction

Dijets - PRL 85, 4217 (2000); PRD 77, 052004 (2008)

Di-photons - PRL 99, 242002 (2007)

Charmonium - PRL 102, 242001 (2009)

W - PRL 78, 2698 (1997)

b-quark - PRL 84, 232 (2000)

J/ ψ - PRL 87, 241802 (2001)

Roman Pot Tag Dijets - PRL 84, 5043 (2000)

Jet-Gap-Jet 1.8 TeV - PRL 74, 855 (1995)

JetGap-Jet 1.8 TeV - PRL 80, 1156 (1998)

Jet-Gap-Jet 630 GeV - PRL 81, 5278 (1998)

Diffraction processes

- Hadronic processes can be characterized by an **energy scale**

➡ Soft processes – energy scale of the order of the **hadron size** (~ 1 fm)
pQCD is **inadequate** to describe these processes

$$\alpha_{soft}(t) = 1.08 + 0.25t$$

➡ Hard processes – “hard” energy scale (> 1 GeV²)

can **use pQCD**

“factorization theorems”

Separation of the **perturbative** part from **non-perturbative**

$$\alpha_{hard}(t) = 1.30 + 0.02t$$

- Most of diffractive processes at HERA ➡ **“soft processes”**

Pomeron flux factor

- x_{IP} dependence is parametrized using a flux factor

$$f_{IP/p}(x_{IP}, t) = A_{IP} \frac{e^{B_{IP}t}}{x_{IP}^{2\alpha_{IP}(t)-1}}$$

- IP trajectory is assumed to be linear $\longrightarrow \alpha_{IP}(t) = \alpha_{IP}(0) + \alpha'_{IP} t$

- B_{IP}, α'_{IP}
their uncertainties

obtained from the fits to H1 forward proton spectrometer (FPS) data

Normalization parameter x_{IP} is chosen such that $x_{IP} \cdot \int_{t_{cut}}^{t_{min}} f_{IP/p} dt = 1$ at $x_{IP} = 0.003$

- $|t_{min}| \approx m_p^2 x_{IP} / (1 - x_{IP})$ is the proton mass
- $|t_{cut}| = 1.0 \text{ GeV}^2$ is the limit of the measurement

J/ ψ + γ production

- ✓ Considering the Non-relativistic Quantum Chromodynamics (NRQCD)
- ✓ Gluons fusion dominates over quarks annihilation
- ✓ Leading Order cross section \longrightarrow convolution of the partonic cross section with the PDF
- ✓ MRST 2001 LO \longrightarrow no relevant difference using MRST 2002 LO and MRST 2003 LO
- ✓ Non-perturbative aspects of quarkonium production
 - Expansion in powers of v
 - v is the relative velocity of the quarks in the quarkonia

NLO expansions in α_s
as one virtual correction
and three real
corrections

NRQCD Factorization

$$g + g \rightarrow \gamma + (c\bar{c}) [{}^3S_1, {}^3S_1^8]$$

$$g + g \rightarrow \gamma + (c\bar{c}) [{}^1S_0, {}^3P_J^8]$$

- Negligible contribution of quarks annihilation at high energies

$$\frac{d^2\sigma_{\text{inc}}}{dydp_T} = \int dx_1 g_p(x_1, \mu_F^2) g_p(x_2, \mu_F^2) \frac{4x_1x_2p_T}{2x_1 - \bar{x}_T e^y} \frac{d\hat{\sigma}}{d\hat{t}}$$

$$\bar{x}_T = 2m_T/\sqrt{s}$$

$$m_T = \sqrt{p_T^2 + m_\psi^2}$$

J/ψ rapidity

9.2 GeV²

\sqrt{s} is the center mass energy (LHC = 14 TeV)

Matrix elements (GeV^3)

$\langle O_1^{J/\psi}({}^3S_1) \rangle$	1.16	$\langle O_1^\Upsilon({}^3S_1) \rangle$	10.9
$\langle O_8^{J/\psi}({}^3S_1) \rangle$	1.19×10^{-2}	$\langle O_8^\Upsilon({}^3S_1) \rangle$	0.02
$\langle O_8^{J/\psi}({}^1S_0) \rangle$	0.01	$\langle O_8^\Upsilon({}^1S_0) \rangle$	0.136
$\langle O_8^{J/\psi}({}^1P_0) \rangle$	$0.01 \times m_c^2$	$\langle O_8^\Upsilon({}^1P_0) \rangle$	0

$$e_b = -\frac{1}{3}$$

$$m_b = 4.5 \text{ GeV}$$

$$m_Y = 9.46 \text{ GeV}/c^2$$

Variables to DDIS

Cuts for the integration over $x_{\mathbb{P}}$

$$x_{\mathbb{P}}^{\min} \leq x_{\mathbb{P}} \leq 0.05$$

$$x_{\mathbb{P}}^{\min} = \frac{\bar{x}_T e^y - 2\tau}{\bar{x}_T e^{-y} - 2}$$

Scales

$$Q_0^2 = 2.5 \text{ GeV}^2$$

$$\Lambda_{QCD} = 0.2$$

$$\mu_F^2 = \frac{(p_T^2 + m_\psi^2)}{4}$$

$$x_2 = \frac{x_1 x_{\mathbb{P}} \bar{x}_T e^{-y} - 2\tau}{2x_1 x_{\mathbb{P}} - \bar{x}_T e^y},$$

$$\hat{s} = x_1 x_2 x_{\mathbb{P}} s, \quad \hat{t} = m_\psi^2 - x_2 \sqrt{s} m_T e^y$$

$$\hat{u} = m_\psi^2 - x_1 x_{\mathbb{P}} \sqrt{s} m_T e^{-y}.$$

Heavy quark production

MBGD, M. M. Machado, M. V. T. Machado, PRD. 81, 054034 (2010)

MBGD, M. M. Machado, M. V. T. Machado, PRC. 83, 014903 (2011)

Heavy quark hadroproduction

o Focus on the following single diffractive processes

$$pp \rightarrow p + (c\bar{c}) + X \qquad pp \rightarrow p + (b\bar{b}) + X$$

o Diffractive ratios as a function of energy center-mass E_{CM}

$$g + g \rightarrow Q + \bar{Q}$$

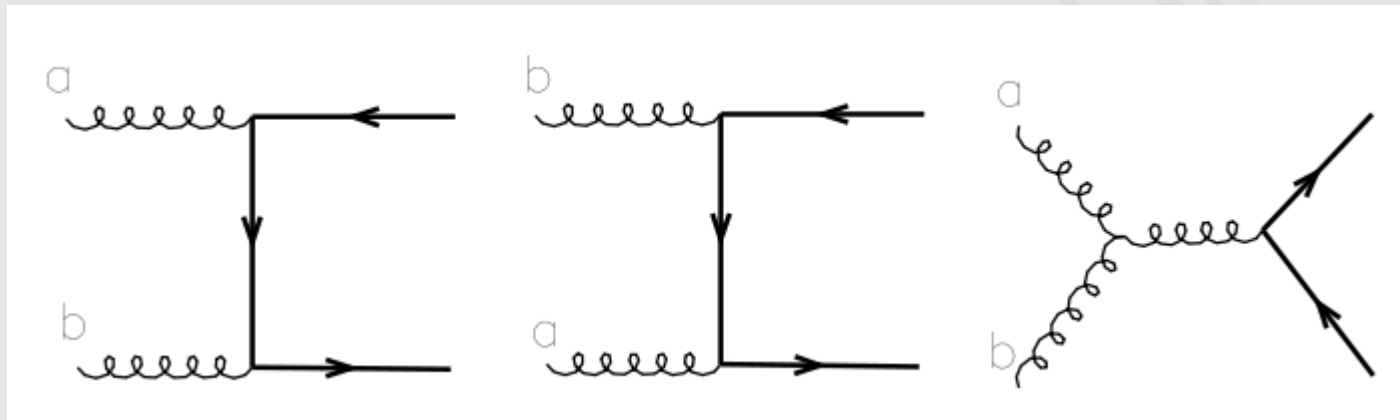

o Diagrams contributing to the lowest order cross section

NLO functions

$$\begin{aligned}
 f_{gg}^{(1)} = & \frac{7}{1536\pi} \left[12\beta \ln^2(8\beta^2) - \frac{366}{7}\beta \ln(8\beta^2) + \frac{11}{42}\pi^2 \right] + \beta \left[a_0 + \beta^2(a_1 \ln(8\beta^2) + \right. \\
 & + a_3\beta^4 \ln(8\beta^2) + \rho^2(a_4 \ln \rho + a_5 \ln^2 \rho) + \rho(a_6 \ln \rho + a_7 \ln^2 \rho) \left. \right] \\
 & + (n_{1f} - 4) \frac{\rho^2}{1024\pi} \left[\ln \left(\frac{1 + \beta}{1 - \beta} \right) - 2\beta \right]
 \end{aligned}$$

a_0	0.108068	a_4	0.0438768
a_1	-0.114997	a_5	-0.0760996
a_2	0.0428630	a_6	-0.165878
a_3	0.131429	a_7	-0.158246

Auxiliary
functions

$$\beta = \sqrt{1 - \rho}$$

$$\begin{aligned}
 \bar{f}_{gg}^{(1)}(\rho) = & \frac{1}{8\pi^2} \left[\left\{ 2\rho(59\rho^2 + 198\rho - 288) \ln \left(\frac{1 + \beta}{1 - \beta} \right) + 12\rho(\rho^2 + 16\rho + 16)h_2(\beta) \right. \right. \\
 & \left. \left. - 6\rho(\rho^2 - 16\rho + 32)h_1(\beta) - \frac{4}{15}\beta(7449\rho^2 - 3328\rho + 724) \right\} + 12f_{gg}^{(0)}(\rho) \ln \left(\frac{\rho}{4\beta^2} \right) \right]
 \end{aligned}$$

Total cross section LO

$$\sigma_{h_1 h_2}(s, m_Q^2) = \sum_{i,j} \int_{\rho}^1 dx_1 \int_{\frac{\rho}{x_1}}^1 dx_2 f_i^{h_1}(x_1, \mu_F^2) f_j^{h_2}(x_2, \mu_F^2) \hat{\sigma}_{ij}(\hat{s}, m_Q^2, \mu_F^2, \mu_R^2)$$

$$\rho = \frac{4m^2}{\hat{s}}$$

$$\hat{s} = x_1 x_2 s$$

$x_{1,2}$ are the momentum fraction

$f_i^{h_1}(x_1, \mu_F^2) f_j^{h_2}(x_2, \mu_F^2)$ are the parton distributions inner the hadron $i=1$ and $j=2$

Partonical cross section

$$\hat{\sigma}_{ij}(\hat{s}, m^2, \mu^2) = \frac{\alpha_S^2(\mu^2)}{m^2} f_{ij} \left(\rho, \frac{\mu^2}{m^2} \right)$$

$\mu_F(\mu_R)$  factorization (renormalization) scale

$$\alpha_S = \frac{g^2}{4\pi}$$

$$\hat{\sigma}(gg \rightarrow Q\bar{Q}) = \sigma_0 \left(\frac{1}{NV} \right) \left[3\mathcal{L}(\beta)\xi_0 + 2(V-2)(1+\rho) + \rho(6\rho - N^2) \right]$$

$$\sigma_0 = \frac{\alpha_s^2}{m^2} \frac{\pi\beta}{24} \rho$$

$$\mathcal{L}(\beta) = \frac{1}{\beta} \log \left(\frac{1+\beta}{1-\beta} \right) - 2$$

$$\beta = \sqrt{1-\rho}$$

NLO Production

$$g + g \rightarrow Q + \bar{Q} + g$$

$$\hat{\sigma}_{ij}(\hat{s}, m_Q^2, \mu_F^2, \mu_R^2) = \frac{\alpha_s^2(\mu_R)}{m_Q^2} \sum_{k=0}^{\infty} [4\pi\alpha_s(\mu_R)]^k \sum_{l=0}^k f_{ij}^{(k,l)}(\rho) \ln^l \left(\frac{\mu_F^2}{m_Q^2} \right)$$

$$f_{gg}(\rho, \mu^2/m^2) = f_{gg}^{(0)}(\rho) + g^2(\mu^2) \left[f_{gg}^{(1)}(\rho) + \bar{f}_{gg}^{(1)}(\rho) \ln(\mu^2/m^2) \right] + O(g^4)$$

Running of the coupling constant

$$\frac{d\alpha_S(\mu^2)}{d \ln(\mu^2)} = -b_0 \alpha_S^2 - b_1 \alpha_S^3 + O(\alpha_S^4)$$

$$b_0 = \frac{33 - 2n_{1f}}{12\pi}, \quad b_1 = \frac{153 - 19n_{1f}}{24\pi^2}$$

$n_{1f} = 3$ (4) charm (bottom)

$$f_{gg}^{(0)}(\rho) = \frac{\pi\beta\rho}{192} \left[\frac{1}{\beta}(\rho^2 + 16\rho + 16) \ln \left(\frac{1+\beta}{1-\beta} \right) - 28 - 31\rho \right]$$

Diffractive cross section

$$\sigma_{h_1 h_2}^{\text{SD}}(s, m_Q^2) = \sum_{i,j=q\bar{q},g} \int_{\rho}^1 dx_1 \int_{\rho/x_1}^1 dx_2$$

$$\times \int_{x_1}^{x_{\mathbb{P}}^{\text{max}}} \frac{dx_{\mathbb{P}}^{(1)}}{x_{\mathbb{P}}^{(1)}} \bar{f}_{\mathbb{P}/h_1}(x_{\mathbb{P}}^{(1)}) f_{i/\mathbb{P}}\left(\frac{x_1}{x_{\mathbb{P}}^{(1)}}, \mu^2\right) f_{j/h_2}(x_2, \mu^2) \hat{\sigma}_{ij}(\hat{s}, m_Q^2, \mu^2) + (1 \Leftrightarrow 2)$$

$\bar{f}_{\mathbb{P}/h_1}(x_{\mathbb{P}}^{(1)})$ \longrightarrow Pomeron flux factor

$$\beta = \frac{x}{x_{\mathbb{P}}}$$

$\beta f_{a/\mathbb{P}}(\beta, \mu^2)$ \longrightarrow Pomeron Structure Function (H1)

KKMR model \longrightarrow $\langle |S|^2 \rangle = 0.06$ at LHC single diffractive events

Parametrization of the pomeron flux factor and structure function \longrightarrow H1 Collaboration

Heavy quarks production at the LHC

Heavy Quark	$\sigma_{\text{inc}}(\sqrt{s} = 14 \text{ TeV})$	$\sigma_{\text{diff}}(\sqrt{s} = 14 \text{ TeV})$	R_{diff}
$c\bar{c}$	7811 [μb]	178 [μb]	2.3 %
$b\bar{b}$	393 [μb]	7 [μb]	1.7 %

Heavy quarks cross sections in NLO to pp collisions

GSP value decreases the diffractive ratio ($\langle |S|^2 \rangle = 0.06$)

Inclusive **nuclear cross section** at NLO

$$\sigma_A = A^2 \sigma_N$$

$$A_{\text{PbPb}} = 208 \text{ (5.5 TeV); } 40 \text{ (6.3 TeV)}$$

$$\sigma_{\text{pPb}}^{\text{SD}} = 0.76 \text{ (0.018) mb}$$

charm (bottom)

$$\sigma_{\text{PbPb}}^{\text{DPE}} = 32.5 \text{ (0.32) } \mu\text{b}$$

Diffractive cross sections @ LHC

Inclusive cross section

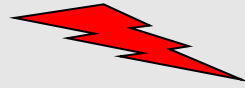

Nucleus-Nucleus collision

	Pb-Pb ($C\bar{C}$)	Pb-Pb ($B\bar{B}$)
$\sigma_A [mb]$	188165, 16	7340, 23

$$A_{Pb} = 240$$

Diffractive cross sections

Coherent	PbPb ($c\bar{c}$)	PbPb ($b\bar{b}$)
σ_{coh}/A^2	3.7 mb	0.06 mb
σ_{coh}^{abs}	9686 - 0.16 mb	156 - 0.003 mb
$R_{coh} [\%]$	86	35
$R_{coh}^{abs} [\%]$	$5.2 - 8.6 \times 10^{-5}$	$2.1 - 3.5 \times 10^{-5}$

❖ Coherent



Pomeron emitted by the nucleus



$$F(t) \approx \exp(R_A^2 t/6)$$

$$R_A = r_0 A^{1/3}$$

$$r_0 = 1, 2 \text{ fm}$$

❖ Predictions to cross sections possible to be verified at the LHC

Very small diffractive ratio

pA cross sections @ LHC

$$\sigma_{pPb}^{SD} = 0.76 (0.018) \text{ mb}$$

charm (bottom)

$$A_{\text{eff}} = 4.39$$

$$S_{GAP}^2 = 0.0287$$

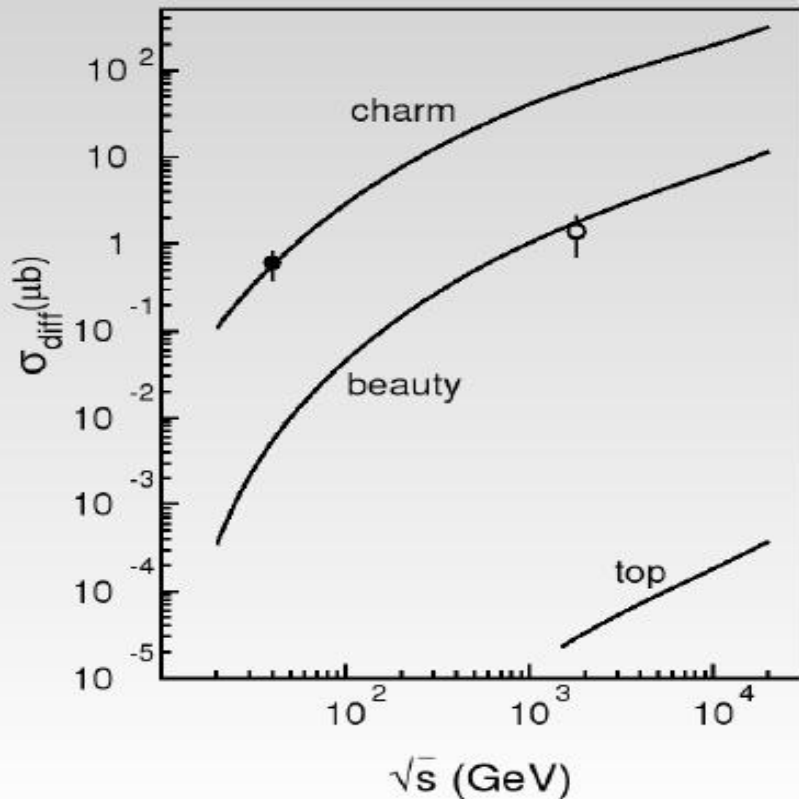

Similar results that

B. Kopeliovich *et al*, 0702106 [arXiv:hep-ph] (2007)

❖ Suppression factor

$$p + p \rightarrow \bar{Q}QX + p$$

$$K = \left\{ 1 - \frac{1}{\pi} \frac{\sigma_{tot}^{pp}(s)}{B_{sd}(s) + 2B_{el}^{pp}(s)} + \frac{1}{(4\pi)^2} \frac{[\sigma_{tot}^{pp}(s)]^2}{B_{el}^{pp}(s) [B_{sd}(s) + B_{el}^{pp}(s)]} \right\}$$

than is suggested by Eq. (70). Therefore, the predicted energy dependence of the survival probability Eq. (70) might be quite wrong and the diffractive cross section at the LHC energy may be overestimated.

$$\sigma_{sd}^{pA}(pA \rightarrow X\bar{Q}QA) = A_{\text{eff}} \sigma_{sd}^{pp}(pA \rightarrow X\bar{Q}Qp)$$

$$\sigma_{pA} \sim 0.8 \text{ mb (charm)}$$

$$A_{\text{eff}} \approx 10.$$

Diffractive cross sections @ LHC

Incoherent	PbPb ($c\bar{c}$)	PbPb ($b\bar{b}$)
σ_{inc}/A^2	1.68 mb	0.03 mb
$\sigma_{\text{inc}}^{\text{abs}}$	4356 – 0.07 mb	85 – 0.001 mb
$R_{\text{inc}}[\%]$	38	19
$R_{\text{inc}}^{\text{abs}}[\%]$	$2.28 - 3.8 \times 10^{-5}$	$1.14 - 1.9 \times 10^{-5}$

Incoherent

*Pomeron emitted by
a nucleon inner the nucleus*

$$A + A \rightarrow X + A + [LRG] + A^*$$

$$\sigma_{A_{diff}} \approx A^2 \sigma_{N_{diff}}$$

- ❖ **No values** to $\langle |S|^2 \rangle$ for single diffractive events in AA collisions
- ❖ **Estimations** to central Higgs production $\longrightarrow \langle |S|^2 \rangle \sim 8 \times 10^{-7}$
- ❖ Values of **diffractive cross sections possible to be verified** experimentally

$$A_{Pb} = 240$$

DPE results at LHC

pp collisions LHC (14 TeV)

$$S_{\text{gap}}^2 = 0.026$$

$Q\bar{Q}$	$\sigma_{\text{inc}} [\mu\text{b}]$	$\sigma_{\text{DPE}} [\mu\text{b}]$	$R_{\text{DPE}} [\%]$
$c\bar{c}$	7811	13.6–0.53	$0.17\text{--}7 \times 10^{-3}$
$b\bar{b}$	393	0.053–0.027	0.01–0.007

Ingelman-Schlein

Bialas-Landshoff

	CaCa [$c\bar{c}$]	PbPb [$c\bar{c}$]	CaCa [$b\bar{b}$]	PbPb [$b\bar{b}$]
$\sigma_{AA}^{\text{DPE}} [\mu\text{b}]$	22.8–2.8	31.1–4.2	0.25–0.14	0.32–0.2
$R_{\text{coh}}^{\text{DPE}} [\%]$	$3 - 0.4 \times 10^{-4}$	$2 - 0.2 \times 10^{-4}$	$8 - 4 \times 10^{-5}$	$4 - 3 \times 10^{-6}$

$$S_{\text{gap}}^2 = 0.032 (0.031) \quad A_{\text{eff}}^2 = 9.52 (6.21)$$

$$S_{\text{gap}}^2 = a / [b + \ln(\sqrt{s/s_0})]$$

$$a = 0.126 \quad b = -4.688 \quad s_0 = 1 \text{ GeV}^2$$

AA collisions LHC

CaCa (6.3 TeV)

PbPb (5.5 TeV)

Ingelman-Schlein > Bialas-Landshoff

d functions

$$P_{gg}(\hat{\tau}) = 6 \left\{ \left(\frac{1}{1-\hat{\tau}} \right)_+ + \frac{1}{\hat{\tau}} - 2 + \hat{\tau}(1-\hat{\tau}) \right\} + \frac{33-2N_F}{6} \delta(1-\hat{\tau})$$

$$P_{gq}(\hat{\tau}) = \frac{4}{3} \frac{1+(1-\hat{\tau})^2}{\hat{\tau}}$$

F_+ : usual + distribution

$$F(\hat{\tau})_+ = F(\hat{\tau}) - \delta(1-\hat{\tau}) \int_0^1 d\hat{\tau}' F(\hat{\tau}')$$

$$\tau_Q = m_H^2 / 4m_Q^2 \ll 1$$

Considering only the heavy-quark limit

Region allowed by Tevatron combination

$$c(\tau_Q) \rightarrow \frac{11}{2}$$

$$d_{gg}(\hat{\tau}, \tau_Q) \rightarrow -\frac{11}{2}(1-\hat{\tau})^3$$

$$d_{gq}(\hat{\tau}, \tau_Q) \rightarrow -1 + 2\hat{\tau} - \frac{\hat{\tau}^2}{3}$$

$$d_{q\bar{q}}(\hat{\tau}, \tau_Q) \rightarrow \frac{32}{27}(1-\hat{\tau})^3$$

CDF Detector

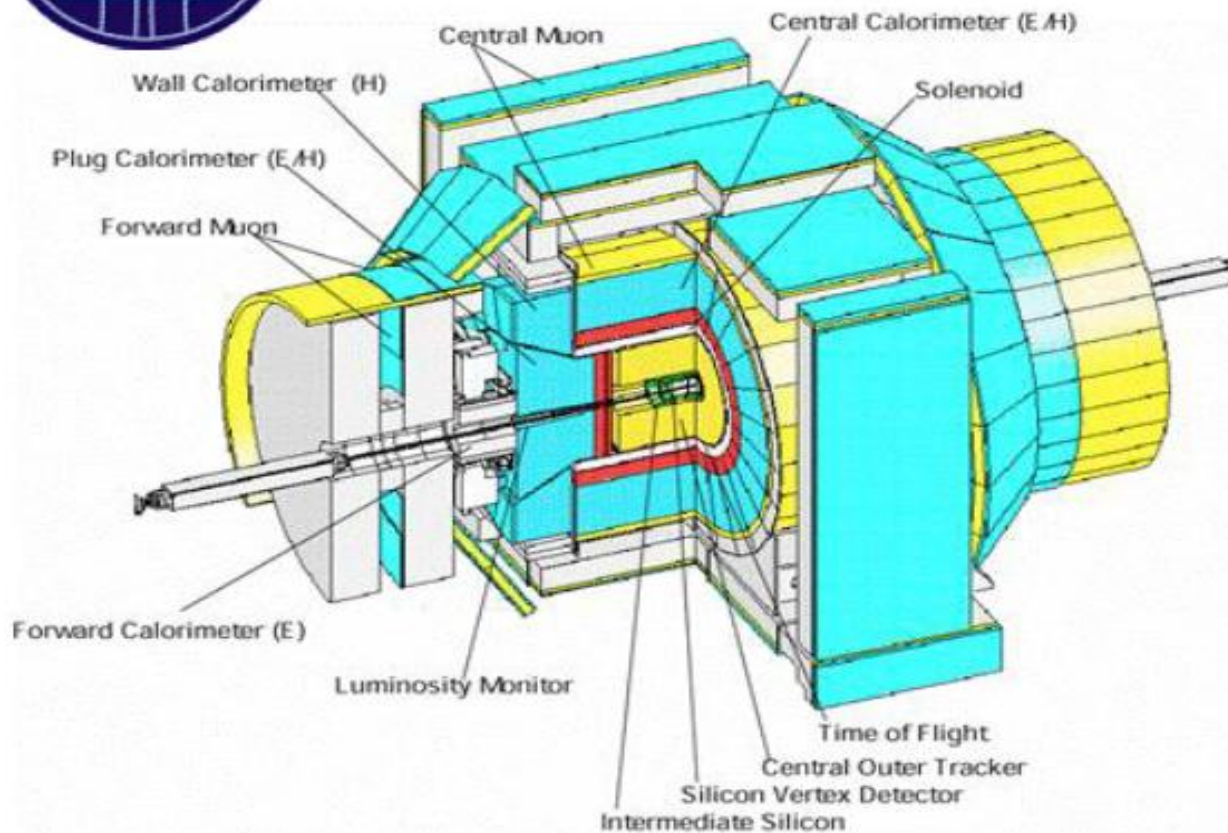

D0 Detector

